

Leica CV5030

Robotic Cover Slipper



Instructions for Use
English

Order No.: 14 0478 80101 - Revision N

Always keep this manual with the instrument.
Read carefully before working with the instrument.

CE

The information, numerical data, notes and value judgments contained in this Instructions for Use represent the current state of scientific knowledge and state-of-the-art technology as we understand it following thorough investigation in this field.

We are under no obligation to update the present Instructions for Use periodically and on an ongoing basis according to the latest technical developments, nor to provide our customers with additional copies, updates etc. of this Instructions for Use.

To the extent permitted in accordance with the national legal system as applicable in each individual case, we shall not be held liable for erroneous statements, drawings, technical illustrations etc. contained in this Instructions for Use. In particular, no liability whatsoever is accepted for any financial loss or consequential damage caused by or related to compliance with statements or other information in this Instructions for Use.

Statements, drawings, illustrations and other information regarding the contents or technical details of the present Instructions for Use are not to be considered warranted characteristics of our products.

These are determined only by the contract provisions agreed between ourselves and our customers.

Leica reserves the right to change technical specifications as well as manufacturing processes without prior notice. Only in this way is it possible to continuously improve the technology and manufacturing techniques used in our products.

This document is protected under copyright laws. All copyrights to this documentation are held by Leica Biosystems Nussloch GmbH.

Any reproduction of text and illustrations (or of any parts thereof) by means of print, photocopy, microfiche, web cam or other methods – including any electronic systems and media – requires express prior permission in writing by Leica Biosystems Nussloch GmbH.

For the instrument serial number and year of manufacture, please refer to the nameplate on the back of the instrument.



Leica Biosystems Nussloch GmbH
Heidelberger Strasse 17 - 19
69226 Nussloch
Germany
Tel.: +49 - (0) 6224 - 143 0
Fax: +49 - (0) 6224 - 143 268
Web: www.LeicaBiosystems.com

Table of Contents

1. Important Information	7
1.1 Symbols and their meanings	7
1.2 Qualification of personnel	11
1.3 Intended purpose	11
1.4 Instrument type	11
2. Safety	12
2.1 Safety notes	12
2.2 Warnings	12
3. Instrument Components and Specifications	15
3.1 Overview - instrument components	15
3.2 Technical data	16
3.3 Standard delivery – packing list	17
4. Instrument Setup	19
4.1 Installation site requirements	19
4.2 Unpacking the Leica CV5030	20
4.2.1 Setting up the Leica CV5030	22
4.3 Preparing and adjusting the instrument	22
4.3.1 Removing or installing the transport anchors	23
4.4 Leveling the instrument	24
4.5 Exhaust system	25
4.5.1 Inserting the active carbon filter	25
4.5.2 Attaching the exhaust hose	26
4.6 Installing the dispenser group	26
4.7 Aligning the dispenser needle height relative to the specimen slide outfeed	29
4.7.1 Checking needle height	29
4.7.2 Setting the needle height	30
4.8 Dispenser needle cleaner (nozzle cleaner)	32
4.9 Connecting the power supply	35
4.10 Installing the accessories	36
4.11 Refilling consumables	38
5. Operation	40
5.1 Control panel functions	40
5.2 Key functions for instrument operation	41
5.3 Switching the instrument on or off	42
5.4 Brief inspection before starting the coverslipping operation	44
5.4.1 Bath insert for HistoCore SPECTRA ST	44
5.5 The coverslipping operation	46
5.6 Interrupting the coverslipping operation	48
5.7 Display indicators and instructions	53
5.8 Button functions for programming	58
5.9 Setting parameter sets	59
5.10 MENU A – parameter settings	59
5.11 MENU B – parameter settings	63
5.11.1 Leaving the parameter and submenu	65
5.12 Recommendation for parameter setting (beginning with firmware 3.01.04)	65

5.13	Determining the optimum parameter setting (MENU A+B).....	68
5.13.1	Procedure.....	68
6.	Workstation operation	74
6.1	Operation as ST5010 – CV5030 workstation	74
6.2	Operation as ST5020 – CV5030 workstation	75
6.3	Important instructions for operation as workstation	78
6.4	Interrupting workstation operation.....	80
7.	Cleaning and Maintenance	81
7.1	Notes on cleaning and maintenance	81
7.2	Daily cleaning and maintenance - overview.....	82
7.3	Weekly cleaning and maintenance	82
7.4	Cleaning and maintenance as necessary.....	83
7.5	Description of the required daily cleaning measures	84
7.5.1	Loading chute and bath transport with transport chain	84
7.5.2	Dispenser needle cleaner (nozzle cleaner).....	84
7.5.3	Glass vial in the dispenser rest position	84
7.5.4	Loading Bath	84
7.5.5	Dispenser needles	84
7.5.6	Cover slip catch tray.....	84
7.5.7	Cover slip magazine.....	84
7.5.8	Skids of the Pick & Place module.....	85
7.5.9	Cleaning and replacing the suction cups	85
7.5.10	Cover slip sensor	85
7.5.11	Specimen slide outfeed.....	86
7.6	Description of the required weekly cleaning measures	86
7.6.1	Dispenser group.....	86
7.6.2	Dispenser needle cleaner (nozzle cleaner).....	87
7.6.3	Specimen slide holder, gripper and output magazines.....	87
7.7	Description for cleaning and maintenance as necessary	88
7.7.1	Active carbon filter.....	88
7.7.2	Discharge chute of the TS5015 or TS5025 Transfer Station for workstation operation	88
7.7.3	Transfer arm of the TS5015 or TS5025 Transfer Station for workstation operation	89
7.8	Procedure for changing the cover slip mountant.....	89
7.8.1	Changing from one xylene-based coverslip mountant to another	89
7.8.2	Changing from a xylene substitute coverslip mountant to a xylene-based mountant	90
7.8.3	Changing from a xylene-based coverslip mountant to a xylene substitute	90
8.	Malfunctions and Troubleshooting	91
8.1	Error codes.....	91
8.2	Troubleshooting.....	93
9.	Optional Accessories	99
9.1	Ordering information.....	99
10.	Warranty and Service	109
11.	Decontamination Confirmation	110

Table of Contents

- 12. Appendix A – Application-related notes and recommendations..... 111**
- 12.1 Leica specimen slide holders, output and coverslip magazines made of plastic 111
- 12.2 Specimen slide holders from other manufacturers..... 112
- 12.3 Specimen slides and gripper mechanism 112
- 12.4 Leica CV5030 – Validated and recommended specimen slides 113
- 12.5 Cover slips 114
- 12.6 Labels for specimen slides..... 114

1. Important Information

1.1 Symbols and their meanings



Warning

Leica Biosystems Nussloch GmbH assumes no liability for consequential loss or damage due to failure to observe the following instructions, particularly in relation to transportation and package handling, and failure to observe the instructions for handling the instrument carefully.



Warning

Leica Biosystems Nussloch GmbH assumes no liability for consequential loss or damage due to failure to observe the following instructions, particularly in relation to transportation and package handling, and failure to observe the instructions for handling the instrument carefully.

Symbol:



Title of the symbol:

Warning

Description:

Warnings appear in a box and are marked by a warning triangle.

Symbol:



Title of the symbol:

Note

Description:

Notes, i. e. important user information, appear in a gray box and are marked by an information symbol.

Symbol:

→ "Fig. 7 - 1"

Title of the symbol:

Item number

Description:

Item numbers for numbering illustrations. Numbers in red refer to item numbers in illustrations.

Symbol:

START

Title of the symbol:

Function key

Description:

Function keys to be pressed on the instrument are displayed as capital letters and bold, black text.

Symbol:

Ready

Title of the symbol:

Software key and/or Display Messages

Description:

Software keys to be pressed on the display and/or messages on the display are displayed as bold, gray text.

Symbol:



Title of the symbol:

Attention

Description:

Indicates that caution is necessary when operating the device or control close to where the symbol is placed, or that the current situation needs operator awareness or operator action in order to avoid undesirable consequences. Consult the Instructions for Use for important cautionary information such as warnings and precautions that cannot, for a variety of reasons, be presented on the medical device itself.

Symbol:



Title of the symbol:

Warning of flammable material

Description:

Inflammable reagents, solvents and cleaning agents are marked with this symbol. Take care to avoid causing a fire by igniting flammable material.

1 Important Information

Symbol:



Title of the symbol:

Manufacturer

Description:

Indicates the manufacturer of the medical product.

Symbol:



Title of the symbol:

Manufacturing date

Description:

Indicates the date when the medical device was manufactured.

Symbol:



Title of the symbol:

In vitro diagnostic medical device

Description:

Indicates a medical device that is intended to be used as an in vitro diagnostic medical device.

Symbol:



Title of the symbol:

CE Label

Description:

The CE marking is the manufacturer's declaration that the medical product meets the requirements of the applicable EC directives and regulations.

Symbol:



Title of the symbol:

UKCA Label

Description:

The UKCA (UK Conformity Assessed) marking is a new UK product marking that is used for goods being placed on the market in Great Britain (England, Wales and Scotland). It covers most goods which previously required the CE marking.

Symbol:



Title of the symbol:

CSA Statement (Canada/USA)

Description:

The CSA test mark means that a product has been tested and fulfills the applicable safety and/or performance standards, including the relevant standards defined or administered by the American National Standards Institute (ANSI), Underwriters Laboratories (UL), the Canadian Standards Association (CSA), the National Sanitation Foundation International (NSF) and others.

Symbol:



Title of the symbol:

China ROHS

Description:

Environmental protection symbol of the China ROHS directive. The number in the symbol indicates the "Environment-friendly Use Period" of the product in years. The symbol is used if a substance restricted in China is used in excess of the maximum permitted limit.

Symbol:



Title of the symbol:

WEEE Symbol

Description:











The WEEE symbol, indicating separate collection for WEEE - Waste of electrical and electronic equipment, consists of the crossed-out wheeled bin (§ 7 ElektroG).

Symbol:



Title of the symbol:

Alternating current

Symbol:	Title of the symbol:	Article number
	Description:	Indicates the manufacturer's catalog number so that the medical device can be identified.
Symbol:	Title of the symbol:	Serial number
	Description:	Indicates the manufacturer's serial number so that a specific medical device can be identified.
Symbol:	Title of the symbol:	Consult Instructions for Use
	Description:	Indicates the need for the user to consult the Instructions for Use.
Symbol:	Title of the symbol:	ON (Power)
	Description:	The power supply is connected upon pushing the power switch .
Symbol:	Title of the symbol:	OFF (Power)
	Description:	The power supply is disconnected upon pushing the power switch .
Symbol:	Title of the symbol:	Fragile, handle with care
	Description:	Indicates a medical device that can be broken or damaged if not handled carefully.
Symbol:	Title of the symbol:	Keep dry
	Description:	Indicates a medical device that needs to be protected from moisture.
Symbol:	Title of the symbol:	Country of Origin
	Description:	The Country of Origin box defines the country where the final character transformation of the product has been performed.
Symbol:	Title of the symbol:	Stacking limit by number
	Description:	To indicate that the items shall not be vertically stacked beyond the specified number, either because of the nature of the transport packaging or because of the nature of the items themselves.
Symbol:	Title of the symbol:	This way up
	Description:	Indicates correct upright position of the transport package.

Symbol:

Storage temperature range:

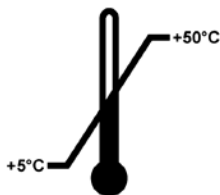
**Title of the symbol:****Description:**

Temperature limit for storage

Indicates the storage temperature limits to which the medical device can be safely exposed.

Symbol:

Transport temperature range:

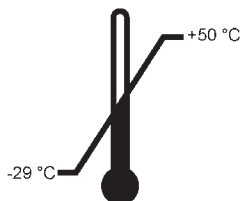
**Title of the symbol:****Description:**

Temperature limit for transport

Indicates the temperature limits for transport to which the medical device can be safely exposed.

Symbol:**Title of the symbol:****Description:**

Humidity limitation for transport and storage

Indicates the range of humidity for transport and storage to which the medical device can be safely exposed.

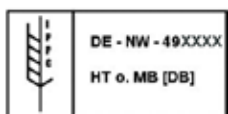
Symbol:**Title of the symbol:****Description:**

IPPC symbol

The IPPC symbol includes

IPPC symbol

- Country code to ISO 3166, e.g. DE for Germany
- Regional identifier, e.g. NW for North Rhine-Westphalia
- Registration number, unique number beginning with 49.
- Treatment method, e.g. HT (heat treatment)

Symbol:**Title of the symbol:****Description:**

Tilt Indicator

Indicator to monitor whether the shipment has been transported and stored in upright position according to your requirements. With a pitch of 60° or more, the blue quartz sand flows into the arrow-shaped indicator window and sticks there permanently. Improper handling of the shipment is immediately detectable and can be proven definitively.

Symbol:**Title of the symbol:****Description:**

Maximum fill volume

Indicates the maximum allowed fill volume of the refillable repository (e.g. bottle), in the adjacent example 200 ml.

1.2 Qualification of personnel

- The Leica CV5030 may be operated by trained laboratory personnel only.
- All laboratory personnel designated to operate this instrument must read these Instructions for Use carefully and must be familiar with all technical features of the instrument before attempting to operate it. The instrument is intended for professional use only.

1.3 Intended purpose

The Leica CV5030 is an automated coverslipper specifically designed for applying mounting media between a slide and coverglass. Then a coverglass is applied to preserve the specimen and to create a uniform visual surface for microscopic research on histological and cytological tissue samples for medical diagnosis by a pathologist, e.g. for cancer diagnosis.

The Leica CV5030 is designed for in vitro diagnostic applications.



Warning

Any use of the instrument other than its intended purpose is considered improper.

Failure to adhere to these instructions may result in an accident, personal injury, damage to the instrument or accessory equipment.

Proper and intended purpose includes compliance with all inspection and maintenance instructions, along with the observance of all instructions in the Instructions for Use.

1.4 Instrument type

All information provided in these Instructions for Use applies only to the instrument type indicated on the cover page.

A nameplate indicating the instrument serial number is attached to the rear side of the instrument. The serial number is also displayed above the loading door on the front side of the instrument.

2. Safety

2.1 Safety notes



Warning

- The safety and caution notes in this chapter must be observed at all times.
- Be sure to read these notes even if you are already familiar with the operation and use of other Leica products.
- The protective devices on the instrument and its accessories must not be removed or modified.
- Only qualified service personnel authorized by Leica may repair the instrument and access its internal components.

Residual risks

- The instrument has been designed and constructed with the latest state-of-the-art technology and according to recognized standards and regulations with regard to safety technology. Operating or handling the instrument incorrectly can place the user or other personnel at risk of injury or can cause damage to the instrument or other property. The instrument may be used only as intended and only if all of its safety features are in proper working condition. Malfunctions which could impede safety must be remedied immediately.
- Only original spare parts and permitted original accessories may be used.

These Instructions for Use include important instructions and information related to the operating safety and maintenance of the instrument.

The Instructions for Use are an important part of the product, and must be read carefully prior to startup and use and must always be kept near the instrument.



Note

These Instructions for Use must be appropriately supplemented as required by the existing regulations on accident prevention and environmental safety in the operator's country.

The instrument's EC Declaration of Conformity and UKCA Declaration of Conformity can be found on the Internet at:

<http://www.LeicaBiosystems.com>

This instrument has been built and tested in accordance with the safety requirements for electrical equipment for measurement, control, and laboratory use. To maintain this condition and ensure safe operation, the user must observe all notes and warnings contained in these Instructions for Use.

2.2 Warnings

The safety devices installed in this instrument by the manufacturer only constitute the basis for accident prevention. Operating the instrument safely is, above all, the responsibility of the owner, as well as the designated personnel who operate, service or repair the instrument.

To ensure trouble-free operation of the instrument, make sure to comply with the following instructions and warnings.

Please note that electrostatic charge may result through direct or indirect contact with the Leica CV5030

Safety instructions - transport and installation**Warning**

- The instrument must be transported in an upright position only (use transport anchors!).
- Two persons are required when lifting or carrying the instrument!
- The Leica CV5030 is intended for use in enclosed rooms only.
- The instrument may be operated with the provided power cable only. This power cable may not be replaced by another. Should the provided power cable not fit in the socket at the installation location, notify the responsible Leica Service.
- Only connect the instrument to a grounded power socket. The protective effect may not be eliminated by an extension cable without a protective grounding conductor. The instrument automatically recognizes the applied voltage/frequency.
- The installation location must be well ventilated, and must contain no sources of ignition of any kind. The chemicals to be used in the Leica CV5030 are highly flammable as well as hazardous to health.
- The instrument may not be operated in hazardous locations.
- Condensation water may form in the instrument if there is an extreme difference in temperature between the warehouse and the installation site and if air humidity is high at the same time. If this is the case, wait at least two hours before switching on the instrument. Failure to comply with this may cause damage to the instrument.
- The instrument must be leveled carefully before commissioning. For more information, refer to ([→ p. 24 – 4.4 Leveling the instrument](#)).

Safety instructions - working with the instrument**Warning**

- The instrument may only be operated by trained laboratory personnel.
- It must only be operated for the purpose of its designated use and according to the instructions contained in these Instructions for Use.
- In the event of an emergency, switch off the power switch and unplug the instrument from the power supply.
- Suitable protective clothing (lab coat, gloves, protective goggles) must be worn when working with reagents. Avoid skin contact with solvents or cover slip mountants.
- Make sure that mountant is applied in the correct amount. For additional information, refer to ([→ p. 59 – 5.10 MENU A – parameter settings](#)). Excess mountant can run from the specimen slide onto the work surface and the transport belt of the bath insert, thus impairing the movement of parts of the instrument. Refer also to ([→ p. 81 – 7. Cleaning and Maintenance](#)).
- During operation, do not block motor-driven components with objects or manual interference. There is a risk of injury from broken glass!
- Do not carry out the discarding movement of the Pick & Place module (cover slip mount) manually! Please observe the notes in ([→ p. 29 – 4.7.1 Checking needle height](#)).
- Never leave the instrument unattended for a long period of time. Particular care must be taken during a power failure to ensure that tissue sections do not dry out.
- Remove all glass parts or other objects away from the Leica CV5030 working area during STOP. Only then may START be actuated.



Warning

- Operate the instrument with the exhaust hose and connection on an external laboratory extraction or under a suitable fume hood. In the process, the corresponding active carbon filter should be used for auxiliary support.
- Since the instrument is intended to be operated with a solvent, there is a fire hazard if work with an exposed flame (e.g. Bunsen burner) is carried out in the direct vicinity of the instrument.
- Ensure that no liquids come into contact with the electronics during work.

Warnings - handling consumables



Warning

Unallowed use of expired consumables

Tissue sample loss / quality degradation and / or instrument damage

- Before using any consumables it is the user's responsibility to ensure that the expiration date has not yet been reached.
- Dispose of any expired consumables immediately and in accordance with the regulations of the laboratory and of the country.



Warning

- Take care when handling solvents and coverslip mountants!
- Always wear rubber gloves, a lab coat and safety goggles when handling the chemicals used in this instrument.
- The reagents used can be both toxic and / or flammable.
- Dispose of used reagents while observing applicable local regulations and the disposal regulations of your company / lab.

Hazards - servicing and cleaning



Warning

- Before each maintenance task, remove the loading bath and the specimen slide holder from the instrument, switch the instrument off and unplug it from the power supply.
- Only Leica service technicians are authorized to open the instrument for maintenance and repair work.
- When using cleaners, please comply with the safety instructions of the manufacturer and the laboratory safety regulations.
- When cleaning the instrument surfaces, do not use scouring powders or solvents containing acetone, chlorine or xylene.
- Clean the lid and the housing with mild and pH-neutral commercial household cleaners. Aggressive cleaning agents and solvents can damage the lacquered surfaces!
- Ensure that no liquids come into contact with the electronics during cleaning.



Note

- Material safety data sheets for reagents can be requested from the respective manufacturer of the chemical.
- Alternatively, the material safety data sheets can be downloaded from the following website: <http://www.msdsonline.com>

3. Instrument Components and Specifications

3.1 Overview - instrument components

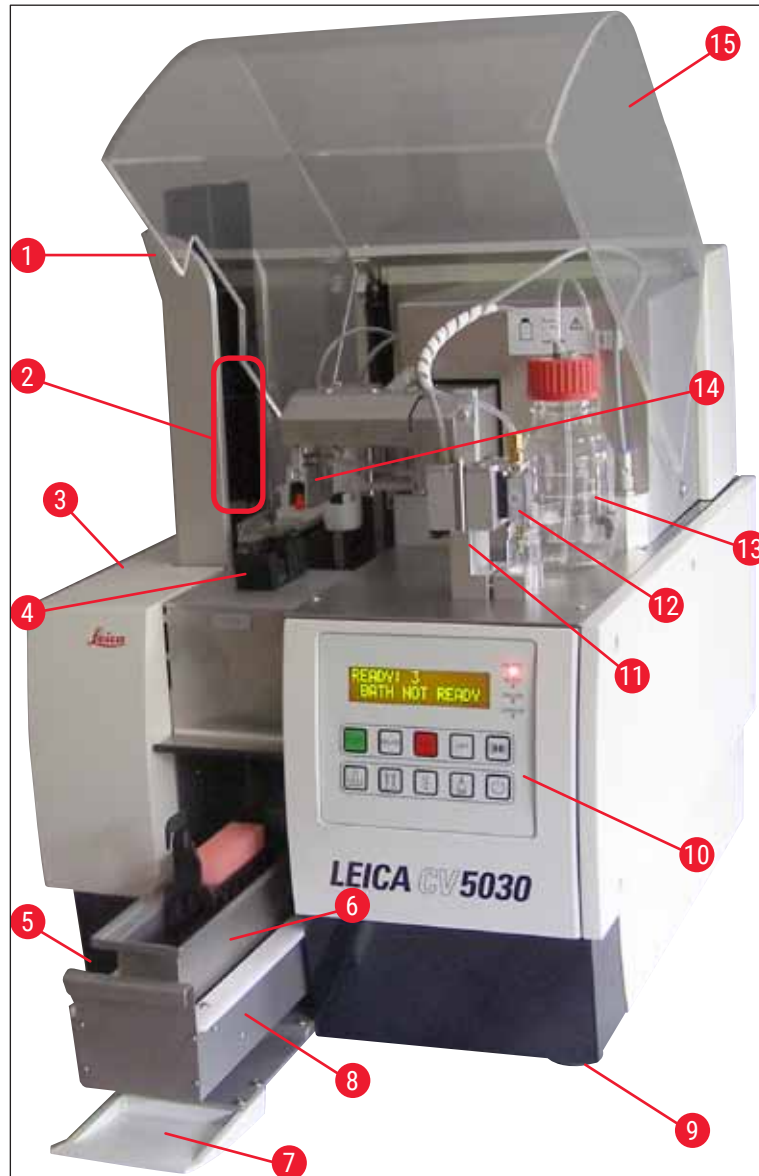

Fig. 1

- | | | | |
|---|-------------------------------------|----|---|
| 1 | Output station for output magazines | 9 | Height-adjustable instrument feet |
| 2 | Output magazines | 10 | Control panel |
| 3 | Maintenance door | 11 | Dispenser rest (park) position (prime position) |
| 4 | Cover slip magazine | 12 | Dispenser group |
| 5 | Main switch | 13 | Bottle for cover slip mountant |
| 6 | Loading bath | 14 | Pick&Place module (cover slip mount) |
| 7 | Input door | 15 | Unit cover |
| 8 | Loading drawer | | |

3.2 Technical data

Model name, model number	Leica CV5030, 14 0478 39700
Nominal supply voltage:	100 – 240 V AC
Nominal supply frequency:	50 – 60 Hz
Power supply voltage fluctuations	± 10 %
Power consumption:	100 VA
Power input fuse:	Thermal Circuit Breaker 5A (3120-...)
Power supply:	C14 inlet acc. to IEC 60320-1 Use wall socket with protective-earth contact
Approvals:	CE, cCSAus
Overall size of device (W x D x H):	Hood closed: 420 x 600 x 600 mm Hood opened: 420 x 600 x 980 mm
Multistainer workstation (W x D x H):	Hood opened: 1620 x 600 x 980 mm
Overall size serial packaging (W x D X H)	1065 x 815 x 935 mm
Width (from the left to the right base):	370 mm
Depth (from the posterior base to the front base):	525 mm
Empty weight (without reagents and accessories)	approx. 57 kg
Overall weight (with reagents and accessories)	approx. 58 kg
Device weight including packaging:	approx. 104 kg
Temperature (operation):	+15 °C to +35 °C
Relative humidity (operation):	20 % to 80 % r. H. (non-condensing)
Temperature (storage):	+5 °C to +50 °C
Temperature (transit):	-29 °C to +50 °C
Relative humidity (transit / storage):	10 % to 85 % r. H. (non-condensing)
Overvoltage to IEC 61010-1:	II
Pollution degree to IEC 61010-1:	2
Means of protection to IEC 61010-1:	Class 1
Degree of protection to IEC 60529:	IP20
EMC class	B
Operating altitude:	Up to a max. of 2000 m above sea level
A-weighted noise level, measured at 1 m distance:	≤ 70 dB (A)
Interfaces:	RS232: Intercommunication interface to stainer / transfer station and service interface RS485: Service interface
Uninterruptible power supply (UPS):	The uninterruptible power supply (UPS) should be designed for a capacity of at least 200 VA over a time frame of 5 minutes.
Heat emmision:	100 J/s
Exhaust extraction:	38.5 m ³ /h
Mechanical connections:	
Hose material:	EVA (ethylene vinyl acetate)
Hose length:	3000 mm

Hose diameter:	32 mm
Hose circumference:	41 mm
Exhaust performance:	38.5 m ³ /h
Extraction:	Active carbon filter and extraction hose for connecting to an external extraction device
Performance:	
Specimen slide throughput:	1 specimen slide in approx. 9 sec.
Usable specimen slides:	All commercially available specimen slides per ISO standard 8037-1. Leica recommends the use of validated Surgipath™ specimen slides.
Cover slip magazine capacity:	Dependent on thickness of the cover slip: 120 pcs. (#1.5) 160 pcs. (#1.0)
Cover slips:	22-24 mm x 40 - 60 mm; #1.0 or #1.5 Following ISO DIN 8255-1
Mountant bottle capacity:	250 ml
Max. fill volume:	200 ml
Coverslip mountant application quantity:	Individually configurable
Mountant types:	See (→ p. 65 – 5.12 Recommendation for parameter setting (beginning with firmware 3.01.04))
Specimen slide holders:	Leica specimen slide holders (20 or 30 specimen slides) and other specimen slide holders (→ p. 99 – 9. Optional Accessories)
Output magazines:	Capacity of 20 or 30 specimen slides (up to 60 specimen slides)

3.3 Standard delivery – packing list

		Order number
The standard equipment for the Leica CV5030 includes the following parts:		
1	Basic instrument (local power cord included)	14 0478 39700
1	Dispensergroup, consisting of:	14 0478 39402
1	Dispenser	
2	Dispenser needles, 21 G	14 0478 40157
2	Dispenser needles, 20 G	14 0478 40158
2	Dispenser needles, 18 G	14 0478 40159
2	Dispenser needles, 16 G	14 0478 40160
1	Accessory kit, consisting of:	14 0478 39734
1	Leica brush	14 0183 30751
1	Allen key, No. 3.0	14 0222 04138
1	Screwdriver 5.5 x 150	14 0170 10702
1	Active carbon filter (xylene)	14 0422 30673
1	Dispenser needle cleaner, assembly	14 0478 40941
2	Glass bottles with lids, for coverslip mountant, 250 ml	14 0464 36537

		Order number
1	Package of 5 pcs. of 30 specimen slide holder, plastic	14 0475 33643
1	Cover for loading bath	14 0478 39584
1	Cover slip catch tray	14 0478 39585
1	Package of 4 pcs. of 30 output magazine	14 0478 39586
1	Loading bath for specimen slide, deep	14 0478 39657
1	Bath insert for Leica 30 specimen slide holder	14 0478 39593
1	Package of 2 pcs. suction cups	14 0478 39701
2	Cover slip magazines, Multi-size™ 40-60 x 22 mm	14 0478 39748
2	Cover slip magazines, Multi-size™ 40-60 x 24 mm	14 0478 39749
1	Glass vial, 12 ml	14 0478 39789
1	Exhaust hose, 3 m	14 0478 39820
1	Instructions for Use, printed (English), with Language CD 14 0478 80200	14 0478 80001

If the supplied local power cord is defective or lost, please contact your local Leica representative.



Note

Carefully check the delivery against the packing list and the delivery note. Should you find any discrepancies, please contact your Leica sales office without delay.

4. Instrument Setup

4.1 Installation site requirements

The location for the Leica CV5030 Robotic Coverslipper must meet the following requirements:



Warning

- The installation location must be well ventilated, and must contain no sources of ignition of any kind.
- The chemicals used in the Leica CV5030 are easily inflammable and pose a health hazard.
- Never operate the instrument in rooms with an explosion hazard.
- Condensation water may form in the instrument if there is an extreme difference in temperature between the storage location and the installation site and if air humidity is high at the same time. If this is the case, wait at least two hours before switching on the instrument.
- Failure to adhere to this waiting period may result in damage to the instrument.
- To ensure proper function of the instrument, it must be set up while maintaining a minimum clearance of 10 cm between the right side or rear panel of the instrument and walls or fixtures. Maintain a clearance of 25 cm between the left side and walls or fixtures to ensure unimpeded access to the service door.
- The instrument must be set up so that the power supply at the rear panel of the instrument and the power plug can be reached at all times.
- The installation location must be protected against electrostatic discharges.

- The instrument requires an installation area of approx. 420 x 600 mm.
- The table must have a sufficient load capacity and rigidity with respect to the weight of the instrument.
- The instrument is designed for indoor use only.
- The power supply must be at a distance no greater than the length of the power cable; do not connect an extension cable.
- The instrument **MUST** be connected to a grounded socket.
- Use only one of the provided power cables that is intended for the local power supply.
- The instrument must not be set up under an air-conditioning system.
- Avoid impacts, direct sunlight and excessive current fluctuations.
- The chemicals used in the instrument are easily inflammable and pose a health hazard.
- All of the device connections are listed in the Instructions for Use.
- We recommend operating the robotic coverslipper with an exhaust hose (max. length of the exhaust hose: 3.00 m) and connection to external laboratory extraction or under a suitable fume hood. The instrument should be operated with the associated active carbon filter in the process.
- The instrument operator has to ensure that ESD safety precautions are maintained.
- The instrument operator is obligated to conform to the local workplace limit values and to document them. Furthermore, the instrument operator must ensure that there is sufficient air exchange and the active carbon filter is changed at the recommended interval. The instrument operator bears responsibility for complying with workplace limits and the measures necessary for this, including documentation.

4.2 Unpacking the Leica CV5030



Note

- When the instrument is delivered, check the tilt indicators (→ Fig. 2-1) on the packaging. If the arrowhead is blue, the shipment was transported laying flat, was tilted at too great an angle or fell over during transport.
- Note this on the shipping documents and check the shipment for possible damage.
- Only personnel authorized by Leica may unpack and install the instrument.

Opening the package

1. Unscrew the 8 screws (→ Fig. 2-2) on the sides of the wooden box and loosen the cover.
2. Carefully lift the cover from the wooden box.



Fig. 2

Removing the accessories

1. Remove the two screws (→ Fig. 2-4) in the side panel (left and right) and take out the transport anchor (→ Fig. 3-1).
2. The box with accessories (→ Fig. 3-2) can now be removed from the shipping package.



Fig. 3

Removing the instrument

1. Unscrew the 8 screws (→ Fig. 2-3) on the bottom of the wooden box on the exterior. Carefully remove the wooden box (→ Fig. 2-5) from the baseplate.
2. Unscrew 2 x 8 screws (front and rear on the instrument, (→ Fig. 4-1), loosen and remove the retaining clips (→ Fig. 4-2) from the baseplate.
3. Remove the dust cover from the instrument. For setting up the instrument, refer to (→ p. 22 – 4.2.1 Setting up the Leica CV5030).



Fig. 4

4.2.1 Setting up the Leica CV5030Setting up the Leica CV5030

1. Grab hold of bottom of the instrument from the front and rear (with at least 2 people; the instrument weighs approx. 57 kg) and place it on a stable laboratory table.
2. When doing so, ensure that the instrument is standing on all four feet.
3. Pull the plastic protective hood off of the instrument by pulling upwards and remove the two adhesive strips (→ Fig. 5-1).
4. Remove the foam safeguard (→ Fig. 5-2) from the output station.
5. Open the loading door (→ Fig. 5-3) and remove the foam cover for the loading bath.
6. Ensure that the provided accessories are complete in accordance with the order.



Fig. 5

4.3 Preparing and adjusting the instrument

To commission the instrument, carry out the following tasks described in the chapters below:

1. Remove the transport anchors.
2. Insert the filter and attach the exhaust hose.
3. Level the instrument.
4. Install the dispenser group.
5. Align the dispenser needle with the specimen slide outfeed.
6. Install the dispenser needle cleaner.

7. Connect the power supply.
8. Use the following accessories:
 - A. Mountant bottle
 - B. Cover slip catch tray
 - C. Cover slip magazine
 - D. Output magazine
 - E. Loading bath
 - F. Dispenser needle cleaner
 - G. Glass vial for dispenser rest position
 - H. Refill consumables

4.3.1 Removing or installing the transport anchors

1. Open the service door (→ Fig. 6-1) on the left side of the instrument and remove the foam (→ Fig. 6-2).

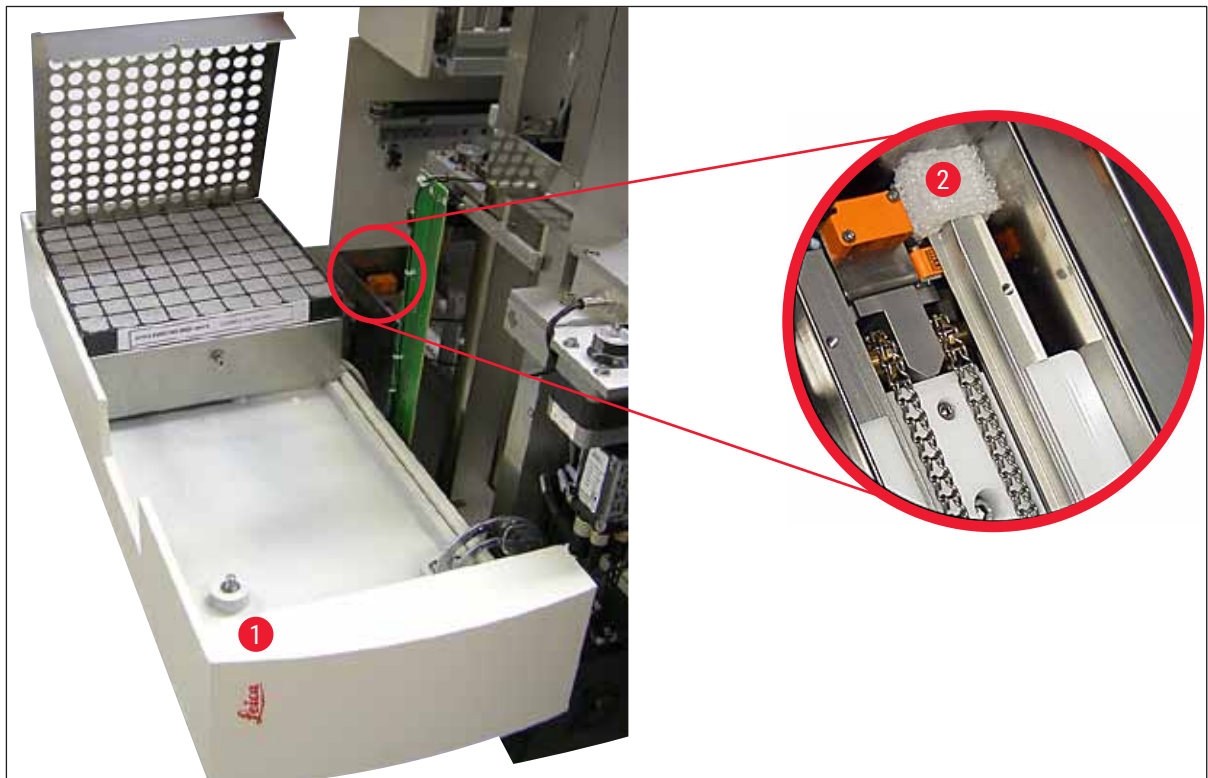

Fig. 6

2. Remove the transport anchor (→ Fig. 7-3) for the Pick & Place module.
3. Remove the transport anchor (→ Fig. 7-4) for the gripper. The gripper slowly moves downward in the process.
4. Using the provided No. 3 Allen key, unscrew the screws (→ Fig. 7-1) and (→ Fig. 7-2) for the two red transport anchors (→ Fig. 7-3) and (→ Fig. 7-4):

4 Instrument Setup

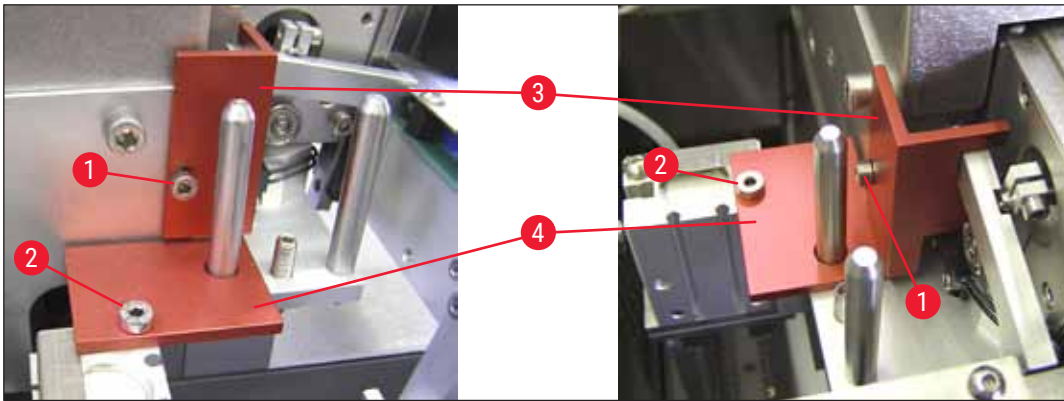

Fig. 7

5. To transport the instrument, reinstall the transport anchors in the opposite order.



Note

We recommend keeping the transport anchors and screws close to the instrument in the provided clear plastic bag.

4.4 Leveling the instrument

1. Move the instrument to its final location on the work surface. When doing so, ensure that all four feet are on the work surface.
2. Open the hood and place a suitable spirit level (→ Fig. 8-1) onto the work surface as shown in (→ Fig. 8).
3. The instrument can be leveled in both directions by screwing or unscrewing the instrument feet (→ Fig. 8-2).



Fig. 8

4.5 Exhaust system



Note

We recommend operating the robotic coverslipper with an exhaust hose and connection to external laboratory extraction or under a suitable fume hood. The associated active carbon filter is intended to be used in a supporting role for this. We recommend replacing the active carbon filter every three months. Please note that the active carbon filter, when used alone, can filter only a limited number of harmful vapors (e.g. xylene). The setup location can differ substantially in terms of solvent loading, room ventilation, room/ambient temperature, room size, etc. In case of doubt, the laboratory owner/operator must have measurements conducted on site to ensure that the legal limits for solvent vapors are not being exceeded.



Warning

Active carbon filter not handled appropriately

Serious injury, instrument damage, threat to environment

- Customers are generally allowed to replace an exhausted active carbon filter with a new one according to the description in (→ p. 25 – 4.5.1 Inserting the active carbon filter).
- Additionally, safety instructions regarding the absence of voltage in the device as well as local laboratory regulations have to be observed.

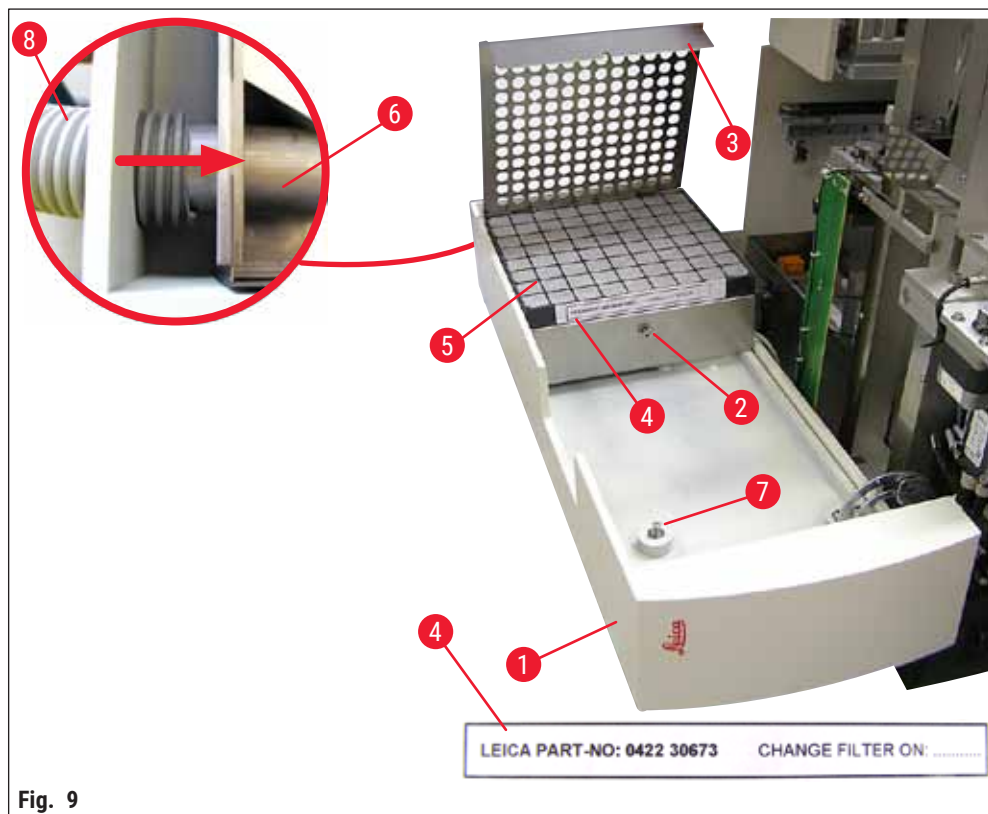

Fig. 9

4.5.1 Inserting the active carbon filter

- Unscrew the slotted screw (→ Fig. 9-7) at the service door (→ Fig. 9-1) on the left side of the instrument and open the service door to the left.

- Unscrew the screw (→ Fig. 9-2) of the filter cover (→ Fig. 9-3) using a No. 3 Allen key and pivot the cover upwards.
- The insertion date can be written down on the adhesive label (→ Fig. 9-4).
- Insert the filter (→ Fig. 9-5), close the cover (→ Fig. 9-3) and secure it back in place using the screw (→ Fig. 9-2).
- Finally, close the service door and retighten the slotted screw.

4.5.2 Attaching the exhaust hose

- For installation, push the exhaust hose (→ Fig. 9-8) onto the pipe (→ Fig. 9-6) as far as it will go (refer to the arrow in the detailed figure); the pipe is on the rear side of the service door (→ Fig. 9-1).



Note

(→ Fig. 9) detail: Assembly of the exhaust hose (→ Fig. 9-8). The filter cover (→ Fig. 9-3) and filter (→ Fig. 9-5) have been removed to show the connecting piece (→ Fig. 9-6).

4.6 Installing the dispenser group

1. Take the dispenser group (→ Fig. 10) out of the packaging.

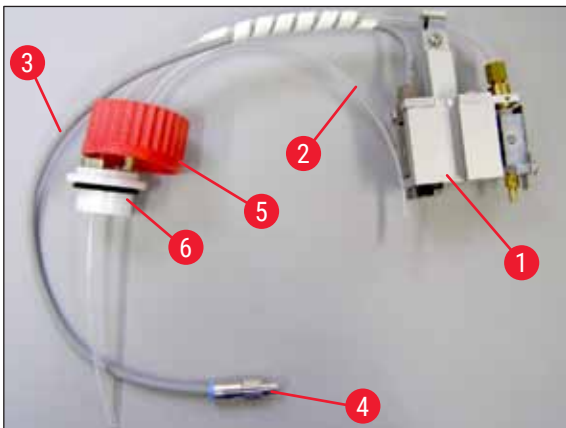

Fig. 10

2. Insert the dispenser (→ Fig. 11-1) into the holder (→ Fig. 11-4) for the prime position (→ Fig. 11).
3. Insert the pressure hose (→ Fig. 10-2) from the cover of the mountant bottle (→ Fig. 10-5) into the compressed air output (→ Fig. 11-5) up to the stop inside.
4. To take the pressure hose back out, press the white ring (→ Fig. 11-6) down and pull out the pressure hose.
5. Plug the cable (→ Fig. 11-3) from the dispenser valve into the socket (→ Fig. 11-7) and screw it in place using the knurled screw (→ Fig. 10-4).
6. Screw the cover (→ Fig. 10-5) onto the mountant bottle (→ Fig. 12-1) and place the mountant bottle into the holder (→ Fig. 12).

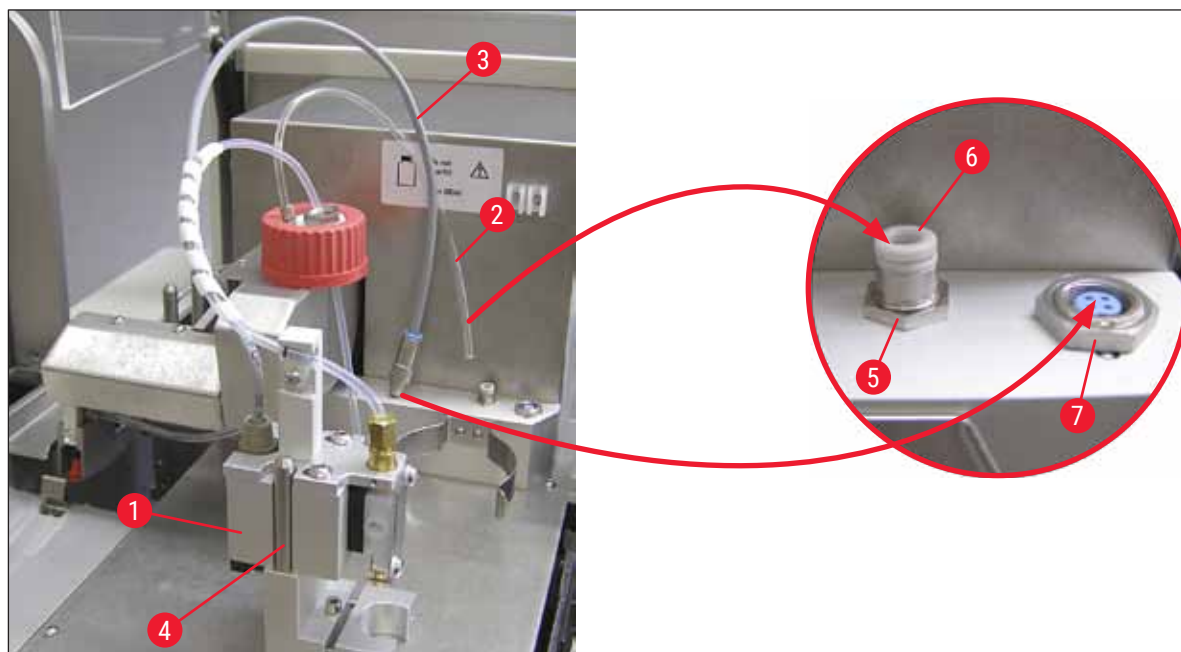

Fig. 11

**Note**

Make sure that the blue shutter ring is on the bottle neck and the O-ring (→ Fig. 10-6) is attached to the dispensing group (→ Fig. 10-5) correctly.

7. Finally, insert the cable and the air hose into the holder (→ Fig. 12-2) provided.

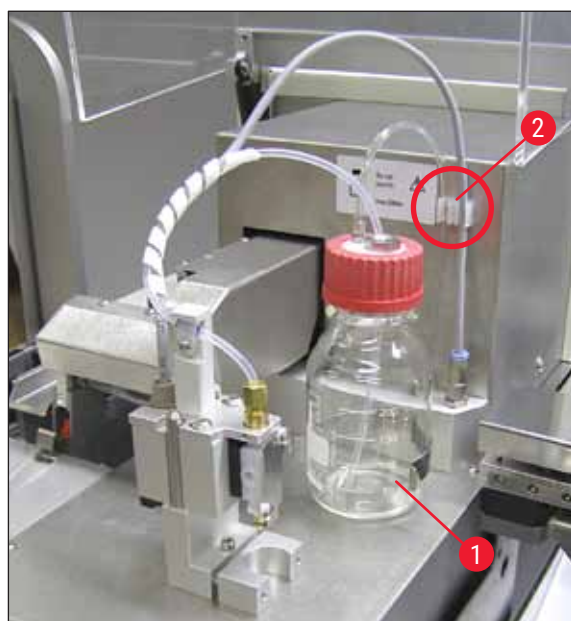

Fig. 12

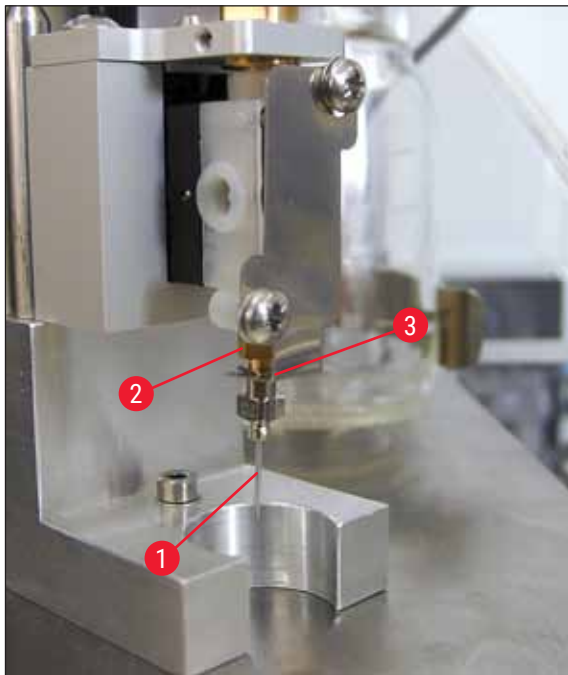

Fig. 13

Inserting the dispenser needle

- Select the dispenser needle to be used for coverslipping from the scope of delivery (→ Fig. 14).
- Insert the dispenser needle (→ Fig. 13-1) into the dispenser needle holder (→ Fig. 13-2) from below and turn the dispenser needle by 45° until one corner (→ Fig. 14-1) is over the retaining plate (→ Fig. 13-3).



Note

Ensure correct positioning for the dispenser needle, since the dispenser needle can loosen during the coverslipping operation. Leaks can create bubbles during coverslipping.

Dispenser needles

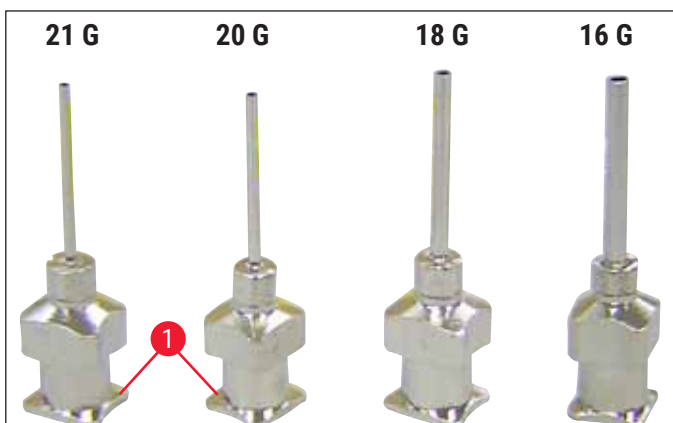

Fig. 14

4.7 Aligning the dispenser needle height relative to the specimen slide outfeed

4.7.1 Checking needle height

- ① The height of the dispenser needle must be aligned to the specimen slide correctly so that no air bubbles are generated while the mountant is applied. The dispenser needle height must not be set too low in order to avoid damage to the specimen on the specimen slide.

Aligning the dispenser needle:

1. Switch off the instrument and unplug it.
2. Open the service door (→ Fig. 15-1) as outlined in (→ p. 26 – 4.6 Installing the dispenser group) (→ Fig. 9).
3. Remove the cover slip catch tray that may already be attached at the specimen slide outfeed.
4. Move the dispenser with the dispenser needle into the working position.
5. There is a pulley (→ Fig. 15-2) that moves the specimen slide outfeed (→ Fig. 15-3) in the area near the opened service door. This can be used to move the specimen slide outfeed to the left and right (see arrow (→ Fig. 15-2)).
6. The dispenser needle can be moved backward and forward in the working position (→ Fig. 15-4) carefully by hand using the Pick & Place module.



Caution

- Do not cause the Pick & Place module to make any downward motion.

7. Now align the highest point of the specimen slide outfeed (→ Fig. 16-2) and the tip of the dispenser needle so that they are touching.

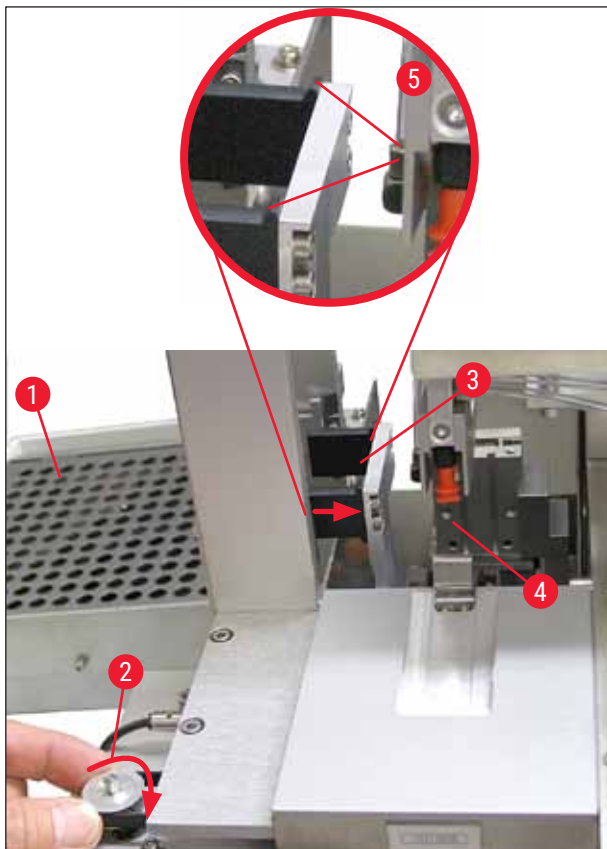

Fig. 15

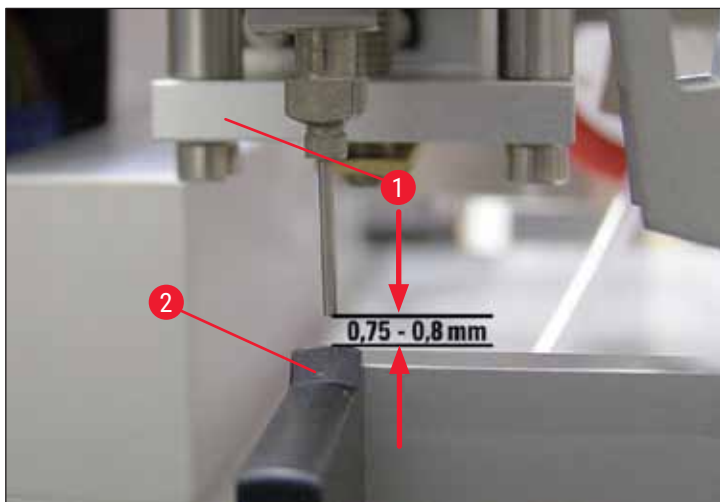

Fig. 16

4.7.2 Setting the needle height

- ① The needle height has to be corrected after reinserting the dispenser needle.

Setting the needle height:

1. Reset the dispenser (→ Fig. 17-2) from the working position (→ Fig. 18-3) to the rest position (→ Fig. 17-1).
2. There is a screw (→ Fig. 18-1) in the working position. This determines the distance between the dispenser needle and specimen slide.
3. The height of the dispenser can be changed by rotating the screw using a No. 3 Allen key (→ Fig. 18-2) (→ p. 17 – 3.3 Standard delivery – packing list):
 - a. Rotating clockwise decreases the distance.
 - b. Rotating counterclockwise increases the distance.
4. Keep rotating the screw clockwise until the dispenser needle is touching the highest point of the specimen slide outfeed (→ Fig. 16-2) (distance = 0 mm). This can be checked by putting the dispenser into the working position.

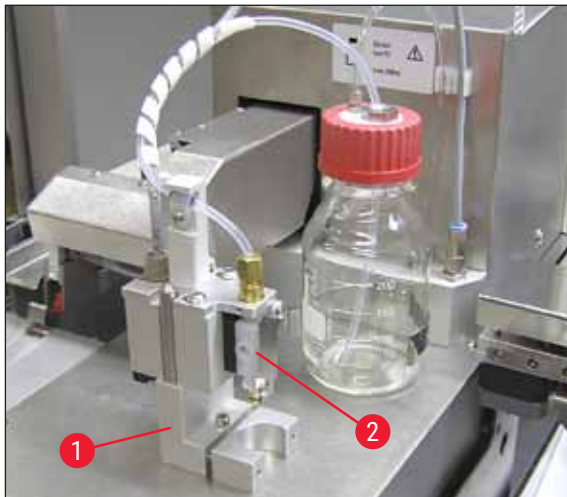

Fig. 17

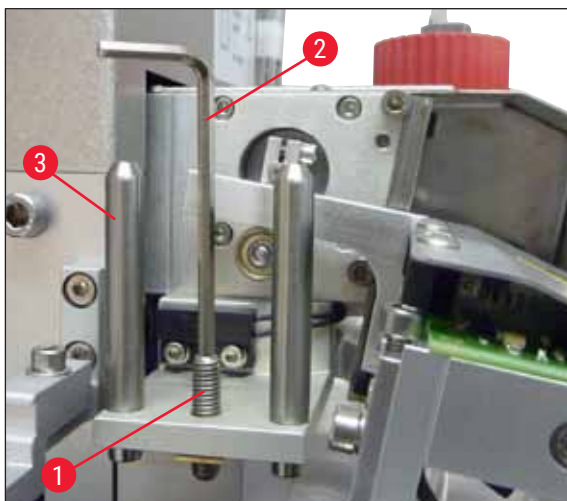

Fig. 18

5. The dispenser is reset into the rest position if the 0 mm distance is set correctly.
6. Now carry out a three-quarters counterclockwise revolution using the No. 3 Allen key.

4 Instrument Setup

7. This achieves the optimum distance of 0.75 - 0.8 mm.
8. The set height of the dispenser needle can be inspected again by a visual inspection from the front (→ Fig. 16).
9. Then close the service door, screw it down tight and reconnect the instrument to the power supply.

4.8 Dispenser needle cleaner (nozzle cleaner)

- ① The dispenser needle cleaner is used to clean excess coverslip mountant off of the dispenser needle after each specimen slide processed.

Parts

Remove the individual components from the packaging and check them for completeness.

The following must be present:

- Container (→ Fig. 19-1) with lid (→ Fig. 19-10)
- Brush (→ Fig. 19-2) (2x)
- Holder (→ Fig. 19-3) with hexagon socket screw (→ Fig. 19-7) and shim (→ Fig. 19-8)
- Mounting bracket (→ Fig. 19-4) 2 hexagon socket screws (→ Fig. 19-9)
- Plastic pipette (→ Fig. 19-5)
- No. 3 Allen key (→ Fig. 19-6)

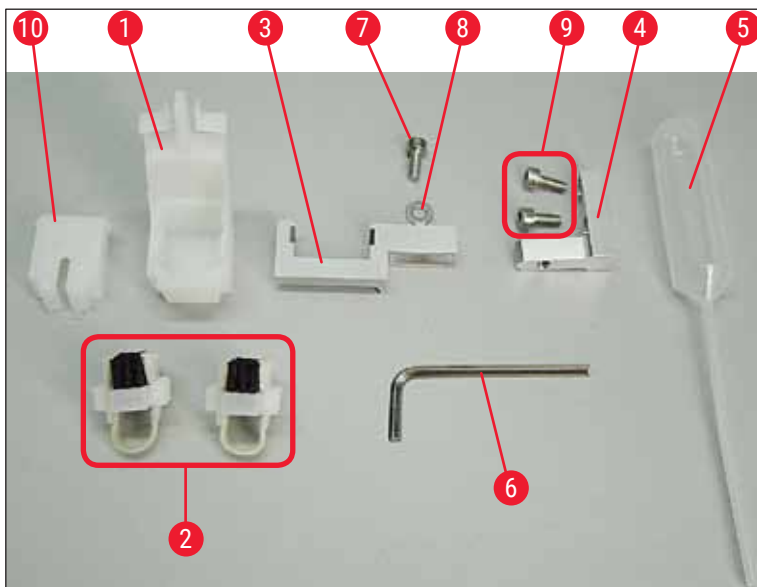

Fig. 19

Assembly of the dispenser needle cleaner

- ① The dispenser needle cleaner consists of a container (for the cleaning fluid) into which a brush is inserted. The brush is moistened with solvent using felt strips (→ Fig. 20-3).

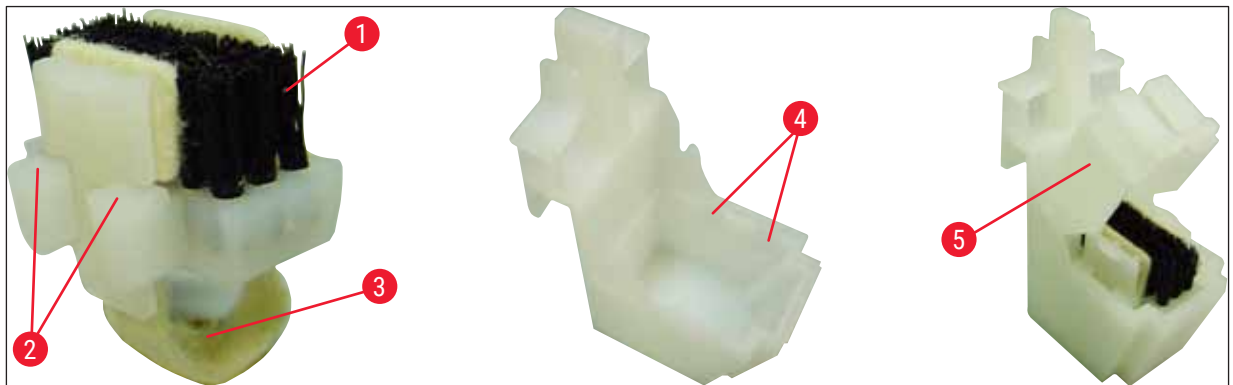

Fig. 20

1. Insert the brush (→ Fig. 20-1) into the container so that the lateral guides (→ Fig. 20-2) (2 each on the left and right) fit into the notches (→ Fig. 20-4) provided.
2. Now, attach the lid (→ Fig. 20-5) and push it down until it clicks into place.

Installation of the dispenser needle cleaner

- ① To install the holder for the dispenser needle cleaner, you must first remove the transport anchors for the Pick & Place module (→ p. 23 – 4.3.1 Removing or installing the transport anchors) (→ Fig. 7).
1. For installation, use the threaded holes (→ Fig. 21-1) of the transport anchor.
 2. First, fasten the mounting bracket (→ Fig. 21-2) in the bores (→ Fig. 21-1) in the housing wall (→ Fig. 21-4) using the two screws (→ Fig. 21-3). Make sure that the mounting bracket is parallel to the edge of the housing wall (ellipse, (→ Fig. 21)).

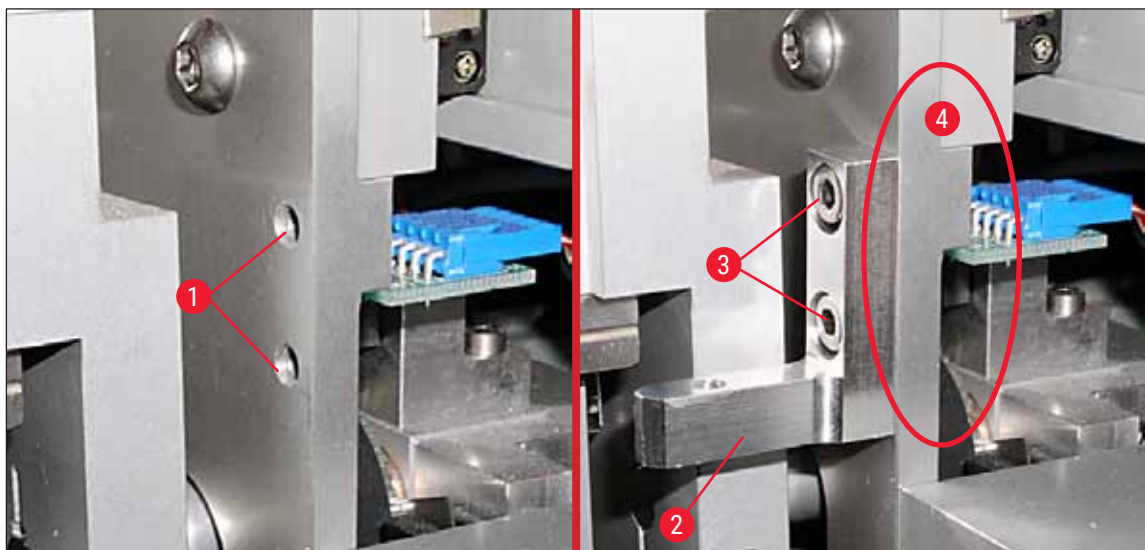

Fig. 21

3. Then, fasten the holder (→ Fig. 22-3) on the mounting bracket using the screw (→ Fig. 22-1) and shim (→ Fig. 22-2).

4. Insert the completely assembled dispenser needle cleaner (→ Fig. 22-4) into the holder as shown in (→ Fig. 22). Press down to ensure that the two lateral mounting clips (→ Fig. 22-6) audibly engage in the notches of the bracket.

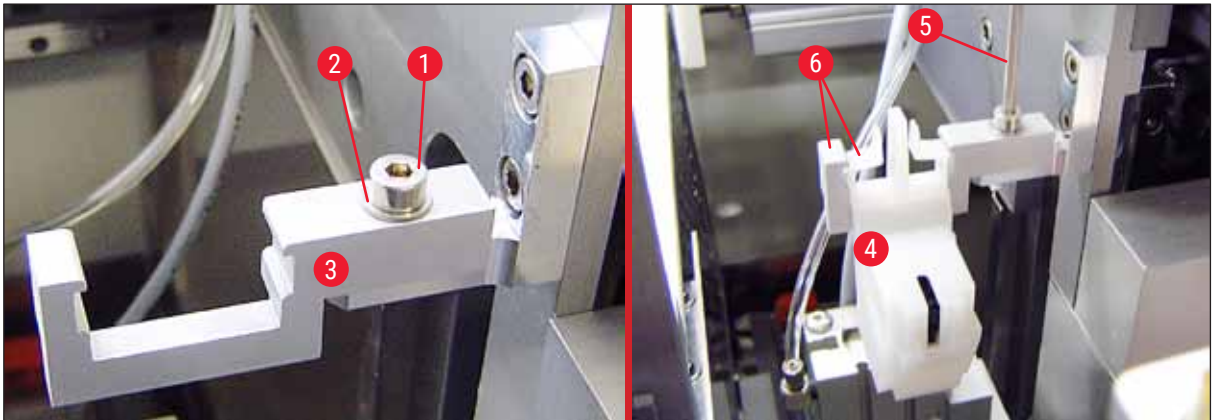

Fig. 22

Alignment to the dispenser needle

1. After the dispenser needle cleaner is installed, it must be aligned relative to the dispenser needle (→ Fig. 23-3).
2. To do so, unscrew the screw (→ Fig. 23-2) using the No. 3 Allen key (→ Fig. 22-5) and align the dispenser needle cleaner by moving the bracket (→ Fig. 23-1) sideways until the dispenser needle (→ Fig. 23-3) move into the correct position in the middle of the cleaning port (→ Fig. 23).

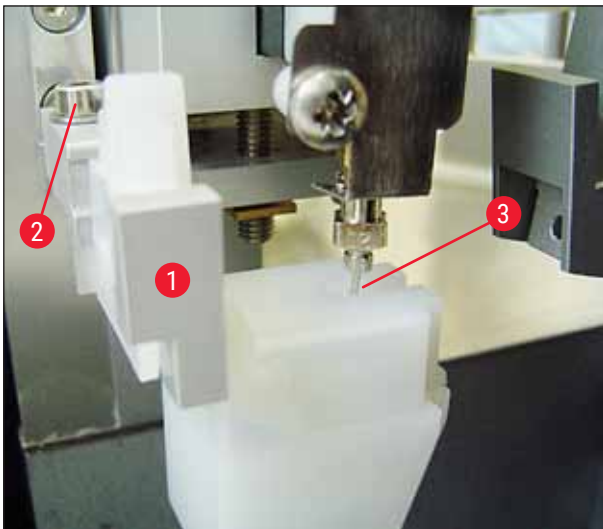

Fig. 23

Checking for freedom of movement

1. Finally, ensure that the gripper (→ Fig. 24-1) does not collide with the dispenser needle cleaner (→ Fig. 24) during its movement or that of the transported specimen slide (→ Fig. 24-2).
2. If the edge of the specimen slide touches the lid of the brush holder, you can carry out a fine adjustment after unscrewing the screws (→ Fig. 21-3) on the housing wall (→ Fig. 21). To do so, use the available play in the bores.



Note

- Fill the container with 5 ml of solvent using the provided plastic pipette (→ Fig. 19-5). Regularly check the level of the container. The solvent being used must be compatible with the coverslip mountant.

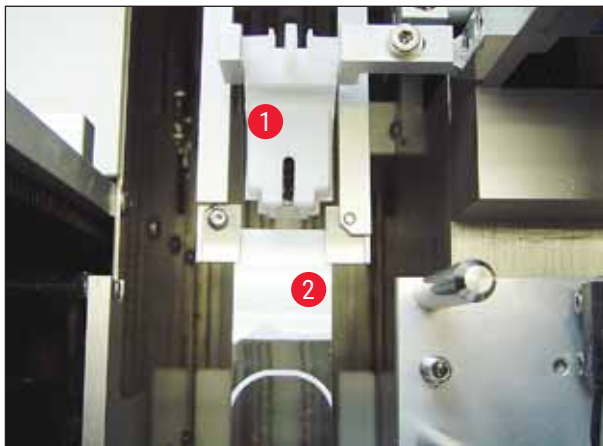

Fig. 24

4.9 Connecting the power supply

- ① The electrical connection is on the left rear side of the instrument (→ Fig. 25-1).
- ① The unit is dimensioned for: 100 to 240 V AC voltage at 50/60 Hz.



Warning

The instrument **MUST** be connected to a grounded power socket.

- Only use a suitable cable that is appropriate for the local power supply (plug must fit on-site wall outlet).

Connecting to power supply

1. Make sure that the coverslipping machine is switched off: The power switch (→ Fig. 25-3) on the front side must be in the "0"= **OFF** position.
2. Insert a suitable power cable into the power input socket (→ Fig. 25-1).

3. The **SERIAL** interface port (→ Fig. 25-2) is intended as an intercommunication interface to either the Leica ST 5010 (via the transfer station Leica TS 5015) or the Leica ST5020 (via the transfer station Leica TS 5025) if both instruments are being operated together as a workstation (→ p. 74 – 6. Workstation operation). Only authorized Leica representatives are allowed to use this port for servicing purposes. The below **RS 485** interface port is completely reserved for servicing purposes by authorized Leica representatives.



Fig. 25

4.10 Installing the accessories

Cover slip catch tray

- ① The cover slip catch tray (→ Fig. 26-2) is used to hold cover slips broken by the cover slip mount.
- » Hook the cover slip catch tray into the slide holder outfeed, inserting it towards the right as shown (→ Fig. 26-1); always ensure that it is securely in place



Note

There are two interface ports:

The **SERIAL** port (→ Fig. 47-3) has two functions. On the one hand this RS 232 port serves as an intercommunication interface to either the Leica ST5010 or the Leica ST5020 via the transfer station Leica TS5025. On the other hand it serves as service interface. For you as a customer only the first purpose is allowed for use.

The **RS 485** port (→ Fig. 47-5) serves a pure service interface. Customers are not allowed to use it for any purpose.

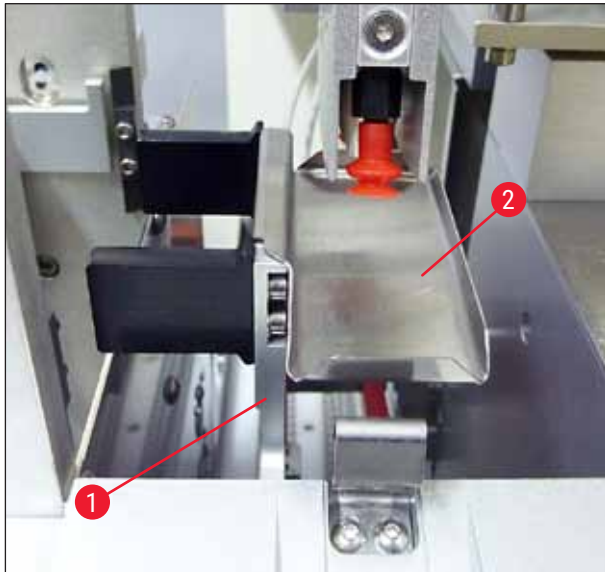

Fig. 26

Coverslip magazine

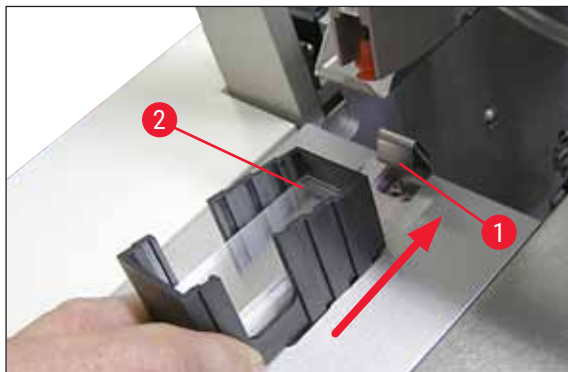

Fig. 27

Coverslip magazine

- Select and fill a cover slip magazine (→ Fig. 27-2) for the desired cover slip type (22 or 24 mm width).
- Tap the cover slip magazine on the edge that points toward the front of the instrument after insertion (this ensures that all of the cover slips are positioned correctly). Then insert the cover slip magazine into the cover slip magazine holder by this edge and then allow the magazine to lock in place on the leaf spring (→ Fig. 27-1).



Fig. 28

Output magazine

- Fill the output station (→ Fig. 28-2) with the desired number of output magazines (→ Fig. 28-1). Up to two size 30 output magazines or three size 20 output magazines fit in the output station.
- Operating the instrument requires that at least one output magazine is inserted.

4 Instrument Setup

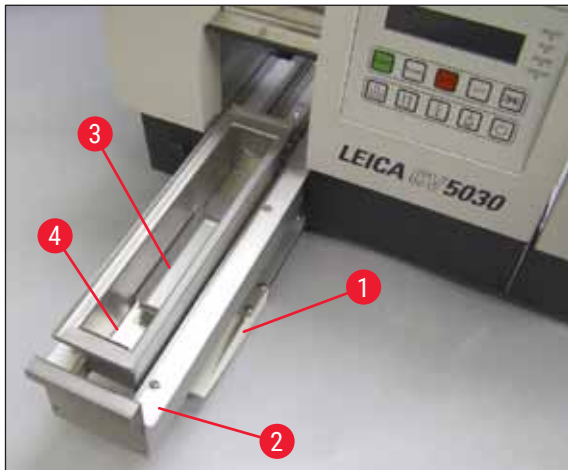

Fig. 29

Loading bath

- Open the loading door (→ Fig. 29-1) and pull out the loading drawer (→ Fig. 29-2).
- Insert the loading bath (→ Fig. 29-4) into the drawer and insert the provided bath insert (→ Fig. 29-3).
- The standard scope of delivery includes the bath insert for the Leica 30 specimen slide holder. The respective associated insert must be used when using other specimen slide holders (Leica metal 20 specimen slide holder, Leica Sakura-type plastic 20 specimen slide holder or specimen slide holders from other manufacturers (→ p. 99 – 9. Optional Accessories)).

4.11 Refilling consumables



Fig. 30

- Fill the loading bath (→ Fig. 29-4) with a solvent compatible with the coverslip mountant. The level should reach up to the specimen slide's label field.
- Fill the glass vial (→ Fig. 30-2) in the rest position with a solvent compatible with the coverslip mountant (approx. 10 ml). The dispenser needle must always be immersed in the solvent.
- The standard scope of delivery includes two different cover slip magazines with different widths (22/24 mm). Fill and insert the magazine (→ Fig. 30-1) corresponding to the cover slip width being used (possible cover slip lengths 40 - 60 mm) (→ p. 99 – 9. Optional Accessories).

**Note**

In order to be able to degas air bubbles generated while filling the mountant bottle (→ Fig. 30-3), the coverslip mountant must sit for 6 - 12 hours (the period depends on the type of coverslip mountant).

- After filling the mountant bottle (→ Fig. 30-3), check the bottle neck and threading for cover slip mountant residue and clean it if necessary.
- To achieve optimal coverslipping quality, leave the filled mountant bottle under a fume hood for 6 - 12 hours covered by a loosely positioned, blue bottle lid. Only insert the bottle into the instrument after doing this.
- Screw the red lid (→ Fig. 30-4) for the dispenser group tightly onto the mountant bottle. While doing so, ensure that the black O-ring is present and positioned correctly on the dispensing group and the mountant bottle's blue shutter ring.

**Warning**

Only glass bottles provided by Leica may be used (see (→ p. 99 – 9. Optional Accessories) and (→ p. 17 – 3.3 Standard delivery – packing list)). Other glass or plastic bottles are not suitable and must not be used on the instrument.

5 Operation

5. Operation

5.1 Control panel functions



Note

(→ Fig. 31) is provided as an example only and shows a valid start display for this instrument.



Fig. 31

The control panel field consists of a membrane keyboard with ten pushbuttons, four LED indicators and a two-line LCD display.

- It is used to control the functions of the instrument and to display the software status.
- The control panel field indicates the current status of the robotic coverslipper and operations in progress.
- Different parameters (settings) can be programmed for the coverslipping operation using the pushbuttons.
- The display shows informational and error messages.
- A pushbutton can fulfill different functions. The differences are listed in (→ p. 41 – 5.2 Key functions for instrument operation) and (→ p. 58 – 5.8 Button functions for programming).



Note

The functions, indicators, settings, etc. outlined in this chapter apply to firmware version 3.01.04 or later.

5.2 Key functions for instrument operation



START begins the coverslipping operation. This is only possible from **READY** or **PAUSE** mode.

LED

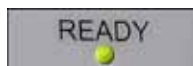

The **READY LED** is illuminated in green in **READY** mode and red in **PAUSE** mode.



Pressing **PAUSE** interrupts the coverslipping operation (**BUSY LED** is illuminated). Processing of the current specimen slide finishes before the instrument switches to **PAUSE** mode.

The **READY LED** is illuminated in red afterwards.

LED



PAUSED appears in the display. Press **START** to continue the coverslipping operation.



STOP interrupts the coverslipping operation immediately.

The **ERROR** is illuminated in red; the display reads **STOPPED** and a signal tone is output.

LED



Press the **START** button to continue working. The instrument is reinitialized when the button is pushed. Refer to (→ p. 42 – 5.3 Switching the instrument on or off), **PRIME** and (→ p. 48 – 5.6 Interrupting the coverslipping operation).



Pushing the **LIFT** button moves the output magazine into the removal position.

LED

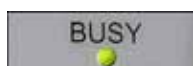

The function is disabled while the **BUSY LED** is illuminated.



Warning

After the output magazine reaches the output position, all specimen slides must be removed before the coverslipping operation can be resumed.

Non-observance can lead to damage of the specimen slide.

RESPOND



A signal tone can be acknowledged using the **RESPOND** button.

RELEASE COVER SLIP



RELEASE COVER SLIP ventilates the Pick & Place module's suction cups. The cover slip is released.

The function is disabled while the **BUSY LED** is illuminated in green.

RELEASE SLIDE



Pressing **RELEASE SLIDE** opens the gripper jaws as long as the button is held down.

The function is disabled while the **BUSY LED** is illuminated in green.

PRIME



Pressing the **PRIME** key opens the dispensing valve as long as the key is pressed.

The function is disabled while the **BUSY LED** is illuminated in green.

VENT MOUNTANT



VENT MOUNTANT generates a vacuum in the coverslip mountant bottle, thereby assisting the coverslip mountant with degassing.

This function is disabled if the **BUSY LED** is illuminated in green.

EXIT



This button is used to exit the configuration menu.

5.3 Switching the instrument on or off



Move the power switch on the front side of the instrument to the **ON = 1** or **OFF = 0** position.

This is followed by a beep.



The instrument initializes after being switched on. The installed software version is shown in the display.

LED



The **READY LED** is illuminated in red.

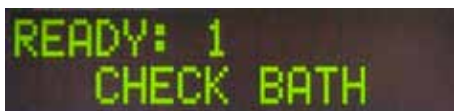

CHECK BATH is the prompt for the user to insert the loading bath after initialization.

To do so, open the loading door and pull out the loading drawer. This is the last chance to remove the cover from the bath.



Note

The digits on the display show the selected coverslipping program (→ p. 59 – 5.9 Setting parameter sets).



When the loading drawer with loading bath is pulled out, **BATH NOT READY** appears on the display.



Warning

IMPORTANT!

BEFORE switching off the instrument, remove the loading bath, cover it and place it under a laboratory fume hood until the next time the instrument is started. Only reinsert the loading bath **AFTER** the instrument is switched back on and initialized to avoid changes to settings and damage to the gripper.



A loaded specimen slide holder can now be inserted into the loading bath. After inserting it, push the loading drawer back and close the loading door.



The message **PRIME POSITION** appears. Take the dispenser out of the rest position; the message **PRIME TO ACT.** is displayed.



Warning

IMPORTANT!

In general, when inserting or removing the dispenser, make sure that caution is used during movements at the time of insertion or removal. If the dispenser falls down, it can cause injuries to users and damage to the dispenser group/instrument.



Press the **PRIME** button once. The message **ACTIVATING** appears and the instrument continues to generate pressure in the coverslip mountant bottle until the pump noise can no longer be heard and the message **PRIME** appears.



Now press the **PRIME** button a second time. Hold the button until the coverslip mountant comes out of the dispenser without bubbles. Do not dispense coverslip mountant into the existing glass vial; use an alternate container instead (e.g. upper part of the cover slip packaging).



If sufficient coverslip mountant has been dispensed, the message **DISP. POSITION** appears. Move the dispenser into working position. The message disappears and the instrument is ready to operate. The displays shows the message **READY**.



If the **READY LED** switches from red to green, the coverslipping operation can be started by pressing the **START** button.

5 Operation

5.4 Brief inspection before starting the coverslipping operation

- ① The following points have to be checked again before starting the coverslipping operation:
- The level of the loading bath (→ Fig. 32-1) must be checked before starting the coverslipping process. Fill the loading bath with the corresponding solvent. The level should reach up to the label field of the specimen slide when a specimen slide holder (→ Fig. 32-2) is inserted.
 - When inserting the loaded specimen slide holder, ensure that the specimen slide receiving the cover slip has the side with the specimen pointing towards the user (instrument front).



Fig. 32

- Push the loading drawer (→ Fig. 32-3) with the loading bath back into the instrument; close the loading door (→ Fig. 32-4) afterwards.
- Furthermore, check and, if necessary, correct the following before starting the coverslipping operation:
 - a. Filling of the dispenser needle cleaner.
 - b. Level of the coverslip mountant bottle.
 - c. Sufficient filling and correct positioning of the cover slip magazine.
 - d. Presence of the output magazines.
 - e. Selection of the desired parameter set (→ p. 59 – 5.9 Setting parameter sets).

5.4.1 Bath insert for HistoCore SPECTRA ST



Note

The Bath Insert and Clip is required to be used with the HistoCore SPECTRA ST specimen slide holder for 30 specimens on the Leica CV5030 Robotic Coverslipper.

**Warning**

- To avoid damaging the specimens specimen slides should never be inserted into a specimen holder on which a clip has already been attached.
- The clip should only be attached after the specimen holder has been removed from the HistoCore SPECTRA ST. Using the Clip during the staining process can cause collisions within the device, which can lead to interruptions of the staining process.
- The specimen slide holder handle (→ Fig. 35-1) has to be removed from the specimen slide holder before inserting it into the Leica CV5030.

Preparing the Leica CV5030 for the HistoCore SPECTRA ST Bath Insert:

1. Open the load drawer of the Leica CV5030 (→ Fig. 32-4) and pull the loading bath forward.
2. Remove the existing bath insert, check the bath for glass debris and clean if necessary.
3. Insert the HistoCore SPECTRA ST Bath Insert (→ Fig. 33-1) into the loading bath.



Fig. 33

Attaching the Clip to the specimen slide holder:

1. Remove the specimen slide holder from the HistoCore SPECTRA ST.
2. Unfold the specimen slide holder handle and hold the specimen slide holder at an angle (→ Fig. 34).



Fig. 34

5 Operation

3. Place the Clip carefully over the specimen slides and take care that only one specimen slide sits in each slot of the Clip (→ Fig. 35).
4. Place the specimen slide holder back horizontally.
5. Using both hands simultaneously, carefully press the Clip downwards until it snaps into position (→ Fig. 35).
6. Remove the specimen slide holder handle (→ Fig. 35-1).

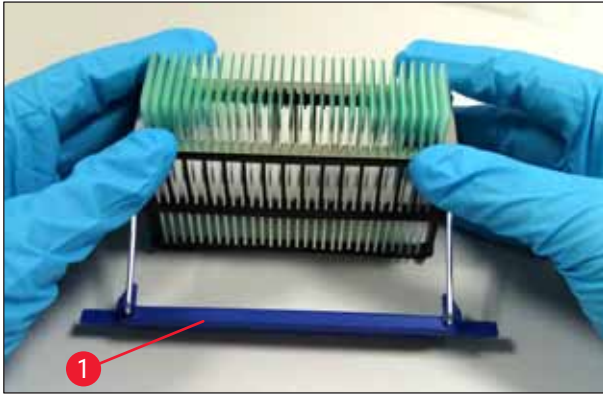

Fig. 35

7. Open the load drawer of the Leica CV5030 and insert the specimen slide holder into the HistoCore SPECTRA ST Bath Insert.
8. Cover slip the specimen slides (→ p. 46 – 5.5 The coverslipping operation).

5.5 The coverslipping operation



After complete initialization, the prime cycle and carrying out preparations (→ p. 42 – 5.3 Switching the instrument on or off), the coverslipping operation can be started by pressing the **START** button (**READY LED** is illuminated in green).

- The loading bath is transported into the position required for the coverslipping operation and the output magazine moves into position.
- The specimen slides are processed sequentially: They are coverslipped in sequence and then pushed into successive positions in the output magazine (from top to bottom).
- The note **FINISHED** is displayed, accompanied by a signal tone, after the last specimen slide is processed. The **READY LED** is illuminated in red.





- The message **FINISHED** has to be confirmed with the **RESPOND** button. Afterwards, the **READY LED** is illuminated in green and the message **READY** appears on the display.
- The output magazine stays at the position of the specimen slide inserted last.
- Press the **LIFT** button to remove the output magazine. The output magazine moves to the output position.
- The output magazines have to be removed and unloaded manually.
- Afterwards, place the empty output magazines in the output station.
- Remove the empty specimen slide holder from the loading bath (not necessary in workstation mode) and replace it with a full specimen slide holder.
- Press the **START** button to continue coverslipping.
- At the end of the workday and before long work breaks, move the dispenser into the park position to keep the dispenser needle from drying out.

**Note**

If the **RESPOND** button is not pressed immediately, the signal tone stops automatically after approx. 15 seconds and the **READY LED** is illuminated in red.

The **RESPOND** button has to be pressed so that the **READY LED** is illuminated in green and work on the instrument can continue.



- If some or all specimen slides are to be removed, use the **LIFT** key to raise the output magazines to the removal position. Removal is not absolutely necessary after each specimen slide holder, as long as sufficient capacity remains in the output magazine for the next coverslipping cycle (max. capacity = 60 specimen slides).

PAUSED
CHECK LIFT



Note

If the space in the output magazine has already been assigned completely but there are still **SPECIMEN SLIDES TO BE COVERSLIPPED** present in the loading bath, this is indicated by the message **PAUSED** and **CHECK LIFT** accompanied by a signal tone.

The **CHECK LIFT** message is a note that the assigned output magazine has to be removed. Insert the empty output magazines and only then confirm the signal tone with the **RESPOND** button.

The **CHECK LIFT** message and signal tone disappear. The empty output magazines are moved into the position required for retrieving the coverslipping operation. The **PAUSE** message remains on the screen.

The coverslipping operation can be continued by pressing the **START** button.



Note

General note:

Full output magazines are automatically moved to the output position with the following exceptions:

- a) If just one 20-pack or 30-pack output magazine is inserted
- b) If just two 20-pack output magazines are inserted
- c) If only part of the output magazine is occupied after ending the coverslipping operation.

The **LIFT** button must be pressed in these cases.

5.6 Interrupting the coverslipping operation



PAUSED



Press **PAUSE** to interrupt the coverslipping operation.

- The currently processed specimen slide is completely coverslipped and pushed into the output magazine, accompanied by the message **PAUSING**.
- If this step is ended, the message **PAUSED** is shown in the display.

A signal tone is emitted at the same time.

- Confirm the signal tone by pressing the **RESPOND** button.



Note

Whenever the instrument is to pause only briefly (e.g. to refill the cover slip magazine), use **PAUSE** to interrupt the instrument without having to run through a complete initialization and prime cycle. If a just partly filled output magazine is to be removed, press **LIFT** and proceed as outlined under (→ p. 46 – 5.5 The coverslipping operation). In **PAUSE** mode, pressing and holding the **RESPOND** button (>2 sec) allows you to change coverslipping parameters or select another parameter set (**SET 1** through **4**) (→ p. 58 – 5.8 Button functions for programming).

- Use the **START** button to continue the coverslipping operation.
- In an emergency or if the coverslipping operation is to be canceled quickly, press the **STOP** button.
- Then, the coverslipping operation is interrupted immediately.
- The message **STOPPED** is displayed accompanied by a signal tone.

- Confirm the signal tone by pressing the **RESPOND** button.



Warning

Remove all glass parts or other objects away from the Leica CV5030 working area after pressing **STOP**. Only then may **START** be actuated.

- Using the **RELEASE COVER SLIP** and **RELEASE SLIDE** buttons, you can release any cover slip that has been picked up or specimen slide that has been gripped.



Warning

- Proceed carefully when removing a specimen slide that has been gripped. Do not manually open the grippers under any circumstances.
- Immediately remove all glass parts, broken glass (e.g. cover slips) or other objects from the instrument's working area.



- Only press the **START** button to continue working after doing so. The instrument then initializes.
- Continue as outlined in (→ p. 42 – 5.3 Switching the instrument on or off).



Warning

The output magazines are moved to the output position automatically after pressing **START**. All remaining specimen slides in the output magazines absolutely must be removed.

Empty coverslip magazine



If the number of cover slips falls below the limit, the message **COVERSLIPS LOW** appears on the display.



The instrument continues to operate until there are no more cover slips in the cover slip magazine. In this case, the messages **PAUSED** and **CS EMPTY** are shown on the display and a signal tone is emitted.



- Switch off the signal tone with **RESPOND**.



- Fill the cover slip magazine and then continue the coverslipping operation by pressing **START**.

Cover slips damaged



- The cover slip sensor between the suction cups in the Pick & Place module automatically detects defective cover slips.



Note

The damaged cover slips are discarded into the cover slip catch tray.

- The coverslipping operation continues automatically if an undamaged cover slip is picked up next.
- The coverslipping operation is interrupted if three damaged cover slips in a row are detected and discarded. The messages **PAUSED** and **COVERSLIP BROKEN** are displayed accompanied by a signal tone.
- Confirm the signal tone with **RESPOND**.



- Check the cover slips in the cover slip magazine for further damage and fill with new cover slips if necessary.



Output magazine full



The specimen slide cannot be gripped



- Then, continue the coverslipping operation by pressing **START**.

The coverslipping operation is interrupted if all of the positions in the output magazine are filled by specimen slides. The instrument is in PAUSE mode.

- The **READY LED** is illuminated in red and **PAUSE** is green. The display shows **PAUSED CHECK LIFT**, accompanied by a signal tone that shows that the output magazine is missing or has to be emptied.

- Confirm the signal tone with **RESPOND**.

- The instrument shows **PAUSED** on the display.
- Remove the full output magazines and insert empty magazines.

- Press **START** and the instrument continues working.

If the gripper fails to grab hold of a specimen slide after three attempts, the device automatically switches to **PAUSE** mode.

- The **READY LED** is illuminated in red, the **PAUSE LED** is green. The display shows **PAUSED CHECK SLIDES**, accompanied by a signal tone that shows that coverslipping cannot continue.

- Confirm and switch off the signal tone with **RESPOND**.

- The instrument shows **PAUSED** on the display.
- Open the load drawer for the loading bath and, inside the specimen slide holder, check:
 1. Whether the individual specimen slides are inserted correctly.
 2. Whether the distances between the individual specimen slides are correct.
 3. Whether the specimen slide is damaged.
- Consider moving the ungripped specimen slide forward by one position in the specimen slide holder or removing it and applying a cover slip by hand.



- If everything is in good condition, work can be continued, as in normal **PAUSE** mode, by pressing **START**.



Warning

Specimen slides that do not conform to ISO 8037/1 are not detected by the instrument and have to be coverslipped by hand.

Pressure or vacuum cannot be reached



If the dispenser system cannot reach the intended pressure or vacuum after a certain time, the instrument automatically switches to **PAUSE** mode.

- The **READY LED** is illuminated in red, the **PAUSE LED** is green. Depending on the error that has occurred, the display reads **PAUSED BOTTLE VACUUM** or **PAUSED BOTTLE PRESSURE**, accompanied by a signal tone indicating that coverslipping cannot continue.

- Confirm and switch off the signal tone with **RESPOND**.

Check the entire dispenser system for leaks.

To do so, check whether:

1. The O-ring is inserted in the cover of the dispenser group and intact.
 2. The connections of the air hose are tight.
 3. Hardened adhesive residue is on the dispenser needle.
- If the dispenser is still in the working position, the message **PRIME POSITION** appears on the display. Put the dispenser into the rest position and continue as outlined in (→ p. 42 – 5.3 [Switching the instrument on or off](#)).

Cover slip missing

If the Pick & Place module loses or breaks a cover slip on the way to the specimen slide that needs to be covered, the instrument automatically switches to **PAUSE** mode. In **PAUSE** mode, the Pick & Place module can be moved forward as necessary, toward the user, to make the specimen slide accessible.

- The **READY LED** is illuminated in red, the **PAUSE LED** is green. The display shows the message **PAUSED CS DROPPED**, accompanied by a signal tone that shows that coverslipping cannot continue.



- Confirm the signal tone with **RESPOND**.

- Remove the cover slip magazine carefully.



Warning

Put the dispenser into park position to prevent damage to the specimen and / or dispenser needle.



Fig. 36

- Carefully pull the Pick & Place module forwards (→ Fig. 36-1) and remove the specimen slide to be coverslipped from the specimen slide outfeed.
- Carefully remove the lost cover slip from the instrument.



Note

Coverslip the removed specimen slide manually or, if the coverslip mountant has already begun to dry, immerse the specimen slide in a compatible solvent, remove the coverslip mountant and re-insert the specimen slide into the instrument for coverslipping.

- Check the suction cups of the Pick & Place module for adhesive residue and, if necessary, clean them using a lint-free cloth moistened with compatible solvent or replace them with new ones (→ p. 85 – 7.5.9 Cleaning and replacing the suction cups).
- Re-insert the cover slip magazine.
- Move the dispenser back into working position.
- Press the **START** key to resume the coverslipping operation.



5.7 Display indicators and instructions



Note

The display of the Leica CV5030 is used to display status and error messages that provide information about the current status of the instrument. Status messages always appear in the bottom line of the display. The top line displays the operating status of the instrument. The following table compiles all status messages. In addition, it indicates to the user which action to carry out. All error messages displayed on the control unit of the device are listed in (→ p. 91 – 8.1 Error codes).

Display	Explanation	Action
	Appears after switching on the instrument. Indicates that the instrument is being initialized.	Do not press any buttons; wait until the device is fully initialized and the next message appears.

5 Operation

Display	Explanation	Action
	The user is prompted to check the loading bath.	Open the loading door, pull out the loading drawer and loading bath. Then check whether there is a lid on the loading bath or an empty rack inside it (remove both if they are present).
	The loading drawer has been pulled out.	Push in the drawer and close the loading door.
	The user is prompted to move the dispenser into the park position.	Move the dispenser into the prime position.
	The user is prompted to press PRIME .	Press the PRIME button.
	Dispensing pressure is built up in the coverslip mountant bottle.	Wait until dispensing pressure has been reached in the coverslip mountant bottle and the pump noise is no longer audible.
	The user is prompted to press the PRIME button again in order to pump mountant from the dispenser.	Hold the PRIME button down until mountant comes out of the dispenser without bubbles. Check whether there are still air bubbles in the dispensing group's coverslip mountant hose. If air bubbles are still present, press PRIME until they have been removed.
	The user is prompted to move the dispenser into working position.	Insert the dispenser into the holder of the working position.
	The instrument is in a state ready to operate.	Pressing START begins the coverslipping operation.
	PAUSE has been pressed. A coverslipping operation for a specimen slide started previously is concluded.	Wait until the instrument is in pause mode.
	The instrument is in Pause mode. A signal tone is audible.	Confirm the signal tone with RESPOND . Press START to continue the coverslipping operation.
	The instrument is in pause mode. No output magazine is present or all output magazines are full.	Check the output position. Empty or insert new output magazines. Press START to continue working.

Display	Explanation	Action
	The number of cover slips has fallen below the limit. The instrument continues to work until the PAUSE button is pressed or all cover slips have been used up.	Press PAUSE to interrupt coverslipping and refill the cover slip magazine. Press START to continue working.
	The instrument is in pause mode. The coverslipping process was interrupted due to the empty cover slip magazine.	Fill the cover slip magazine. Pressing START allows work to continue.
	The instrument is in pause mode. There is no loading bath in the loading drawer.	Insert a loading bath into the loading drawer. Press RESPOND as confirmation, then press START to continue coverslipping.
	The instrument is in pause mode since a vacuum could not be attained in the system.	Check the coverslip mountant bottle/dispenser system for leaks and whether both O-rings are present; replace the O-rings, if necessary.
	The instrument is in pause mode; the working pressure in the system could not be attained.	Check the coverslip mountant bottle/dispenser system for leaks and whether both O-rings are present; replace the O-rings, if necessary.
	The instrument is in pause mode; the system was unable to grab a specimen slide.	In the specimen slide holder, check whether the specimen slides are inserted correctly and undamaged. If the message occurs repeatedly despite the specimen slides being inserted correctly, remove the specimen slides and apply cover slips by hand.
	At least three cover slips in a row are defective.	Check the cover slips in the cover slip magazine. If the messages occurs repeatedly despite the cover slips being intact, clean the cover slip sensor. If the message persists, clean the Pick & Place module (skids and suction cups).

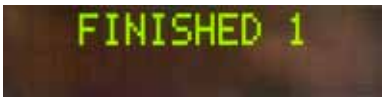
Display	Explanation	Action
	The user has pressed the STOP button.	<p>The output magazine, if loaded, has to be removed from the instrument. Grabbed specimen slides or held cover slips also must be removed from their position by pressing the respective RELEASE SLIDE or RELEASE COVERSLIP button.</p> <p>Pressing START reinitializes the instrument. Afterwards, proceed the same as when switching on the instrument (→ p. 42 – 5.3 Switching the instrument on or off).</p> <p>IMPORTANT!</p> <p>If the instrument is operated as a workstation, the user must ensure that before reinitialization, no rack is in the transfer station.</p>
	The coverslipping operation was ended. The number after FINISHED corresponds to the selected SET 1-4 program.	Remove the cover slipped specimen slides.

Display	Explanation	Action
	The Pick & Place module loses the coverslip on the way to the coverslipping position.	As soon as the display reads CS DROPPED , the instrument goes automatically into PAUSE mode. Notice: Move the dispenser into the park position , move the Pick & Place module towards the user and remove the specimen slide. You can now coverslip the specimen slide manually. As an alternative, immerse the specimen slide in a compatible solvent and remove the coverslip mountant, then re-insert the specimen slide into the instrument for coverslipping.
	<ol style="list-style-type: none"> 1. The suction cups, the cover slip sensor and/or the skids on the Pick & Place module are stuck in place with coverslip mountant. 2. The suction cups are deformed. 3. The cover slip magazine is inserted incorrectly. 4. The suction cups are not correctly seated on the Pick & Place module. 	<ol style="list-style-type: none"> 1. Clean the suction cups, cover slip sensor and/or the skids of the Pick & Place module using a lint-free cloth moistened with compatible solvent or replace them with new ones (→ p. 85 – 7.5.9 Cleaning and replacing the suction cups). 2. Replace the suction cups with new ones (→ p. 85 – 7.5.9 Cleaning and replacing the suction cups). 3. Check that the cover slip magazine is seated correctly. 4. Check that the suction cups are seated correctly; if necessary, pull them off and reattach.



Note

The following status messages are displayed only if the instrument is connected to a staining machine (Leica ST5010 AutoStainerXL or Leica ST5020 Multistainer) via a transfer station.

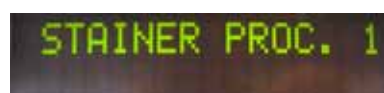

Indicates that a specimen slide holder that has been transferred from the staining machine is in the process of coverslipping.

Wait for the specimen slide to finish processing.

5 Operation

READY: 1
TS FULL

There are two empty specimen slide holders on the discharge chute of the transfer station.

Remove the empty specimen slide holders from the discharge chute of the transfer station.

PAUSED
TS FULL

The capacity of the discharge chute has been reached. There are three empty specimen slide holders on the discharge chute of the transfer station.

The empty specimen slide holders absolutely must be removed from the discharge chute of the transfer station, otherwise no other specimen slide holders can be transported from the staining machine to the Leica CV5030.

5.8 Button functions for programming

Press and hold for 2 s



Fig. 37

Press and hold **RESPOND** for approx. two seconds to set the programs and parameter sets the instrument uses to operate.

The individual parameter sets are set using two submenus:

MENU A (→ Fig. 37) and **MENU B** (→ Fig. 38)

- Toggle between the two submenus by briefly pressing **RESPOND**. The active submenu (→ Fig. 37-1) is displayed in the right half of the top display line.
- There are four selectable programs (**SET 1** through **4**) that are displayed on the upper left half of the display (→ Fig. 37-2).

The bottom line in the display shows the parameters in **MENU A**:

STK - Length of the coverslip mountant stroke

VOL - Quantity of the coverslip mountant

TYP - Pressure in the mountant bottle

LEN - Length correction for the coverslip mountant stroke

Press 1x





Fig. 38

MENU B includes the following parameters:

- CSP** - Cover slip placement position
- STP** - Starting point for the coverslip mountant stroke
- SPK** - Volume of the signal tone
- LIM** - Cover slip limit setting

5.9 Setting parameter sets

① There are a total of four programs (**SET 1** to **SET 4**) that can be stored in the instrument with different parameter settings.

- Pressing the **START** button calls up the next higher program.
- Pressing the **PAUSE** button calls up the next lower program (→ Fig. 39).

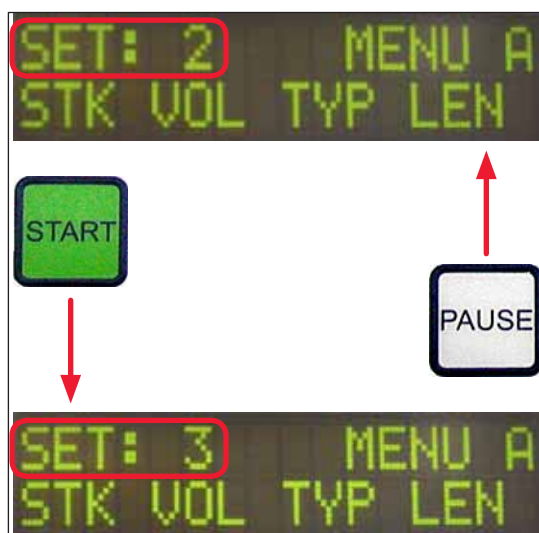

Fig. 39

5.10 MENU A – parameter settings

① The individual buttons used to select and program the respective parameters are in the bottom row of the control panel field.

5 Operation

Example:

1. To modify the length of the coverslip mountant stroke (**STK**), press the **RELEASE COVERSLIP** button (→ Fig. 40).
2. The name of the parameter and its currently set value appear on the display (→ Fig. 40-1). The selected program (**SET 1** through **SET 4**) is shown in the top right.
3. The **START** or **PAUSE** buttons can be used to increase or decrease the value of the parameter respectively. Press **RESPOND** as confirmation. The procedure for changing a value is identical for all parameters.

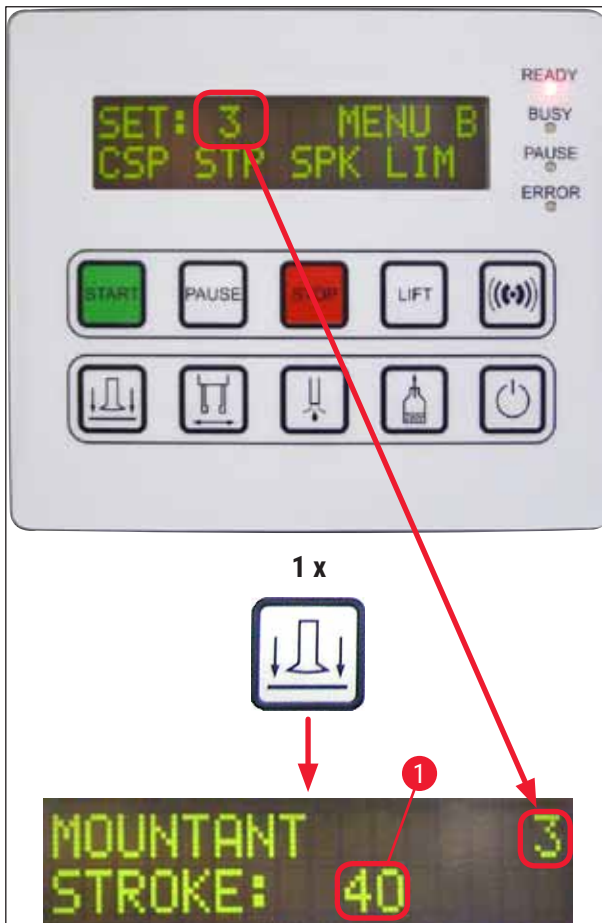
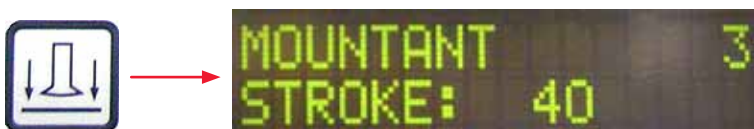

Fig. 40

Mountant Stroke – stroke length of the coverslip mountant



The quantity and stroke length of the coverslip mountant is adapted to the cover slip length.

Label field (→ Fig. 41-1), Stroke length (→ Fig. 41-2)

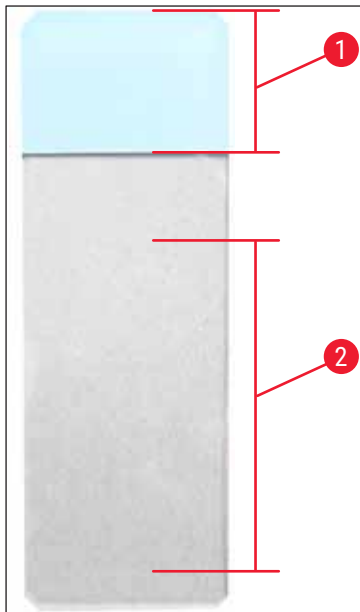

Fig. 41

Mountant Stroke:	40	= 40 mm Cover slip length
Mountant Stroke:	50	= 50 mm Cover slip length
Mountant Stroke:	55	= 55 mm Cover slip length
Mountant Stroke:	60	= 60 mm Cover slip length

Mountant Volume – volume of the coverslip mountant



The opening time for the dispenser valve is set in increments of 1:

Adjustment options for the opening time:

In increments of 1 from 1 (short) to 9 (long).

1 = less coverslip mountant to 9 = maximum quantity of coverslip mountant

- The quantity of the coverslip mountant applied also depends on the composition of the mountant (e.g. viscosity) and the selected dispenser needle (different diameters).

Mountant Type – dispensing pressure



5 Operation

The pressure needed to dispense the coverslip mountant is set in increments of 1:

1 = 100 mbar/lowest pressure to 10 = 1000 mbar/highest pressure

- An increase of "1" increases the pressure by 100 mbar.
- The pressure has to be adapted based on the coverslip mountant used (different viscosities) and the dispenser needle used (different diameters).

Stroke Length Corr – stroke length correction of the coverslip mountant



The stroke length for the coverslip mountant set by the **STK** (length of the coverslip mountant stroke) parameter can be shortened by changing **LEN** (→ Fig. 42-2) (length correction for the coverslip mountant stroke).

- The reduction only applies from the label field (→ Fig. 42-1) area to the middle of the specimen slide.
- The factory preset value is 0.

In increments of **10** from:

0 = no change to **-100** = maximum change



Note

The application quantity is not changed, but only the length of the coverslip mountant stroke.

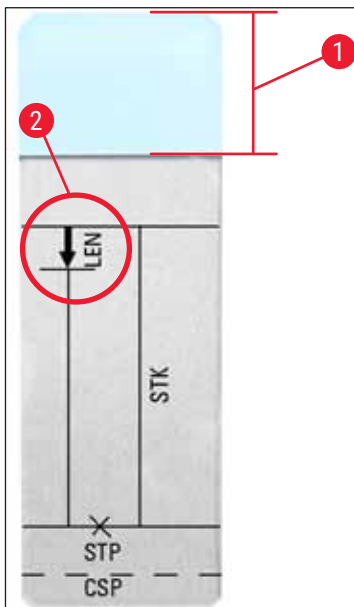

Fig. 42

- LEN** = STROKE LENGTH CORRECTION
(length correction for the coverslip mountant application)
- STK** = MOUNTANT STROKE
(length of the coverslip mountant application)
- STP** = STROKE POSITION CORRECTION
(starting point of the coverslip mountant application)
- CSP** = COVERSIP POSITION CORRECTION
(cover slip placement position)

5.11 MENU B – parameter settings

Coverslip Position Corr – correction of the cover slip placement position

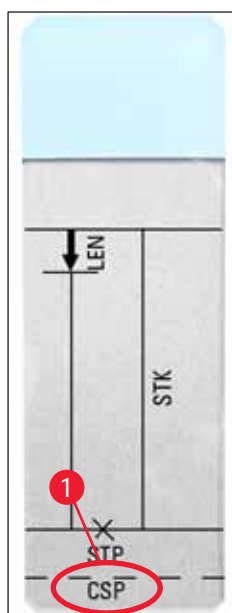

Fig. 43



The cover slip placement position can be modified using the **CSP** (→ Fig. 43-1) (cover slip placement position) parameter (→ Fig. 43).

- If the cover slip placement position is to be moved towards the edge of the specimen slide, then select a negative value between -5 and -30.
- If the cover slip placement position is to be moved towards the label field, a positive value between +5 and +30 has to be selected.
- The changes can be made in increments of 5.
One increment corresponds to 0.5 mm.
- The factory preset value is 0

Stroke Position Corr – start position correction of the coverslip mountant stroke

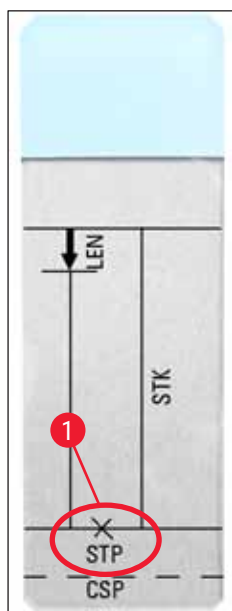

Fig. 44



The coverslip mountant stroke position can be changed using the **STP** (→ Fig. 44-1) (starting point for the coverslip mountant stroke) parameter.

- If the starting point for the coverslip mountant stroke is to be moved towards the edge of the specimen slide, then select a negative value between -10 and -100.
- If the starting point for the coverslip mountant stroke is to be moved towards the label field, a positive value between +10 and +100 has to be selected.
- The changes can be made in increments of 10.
One increment corresponds to 1.0 mm.
- The factory preset value is 0.

5 Operation

Speaker Volume Level – volume of the audible signal



Setting for the volume of key tones, messages and the signal tone:

In increments of 1 from 1 (quiet) to 3 (loud)



Note

The signal tone and audible signals of the buttons cannot be disabled completely.

Coverslip Limit Adjustment – setting for the cover slip limit



The setting of the **LIM** (cover slip limit setting) parameter defines what quantity of cover slips remaining in the coverslip magazine is used to display the **COVERSLIPS LOW** notice on the display. This notifies the user of a critical (low) number of cover slips remaining in the magazine.

The setting is made as follows:

1. Place a cover slip stack (approx. 30 - 40 pieces) in the empty coverslip magazine.
2. Then, press the **START** button.



3. The Pick & Place module moves to the cover slip magazine and lowers itself down to the top cover slip. Then it returns to its original position.
4. The setting for the new cover slip limit has now been saved and the overview for the parameter setting in **MENU B** reappears on the display.

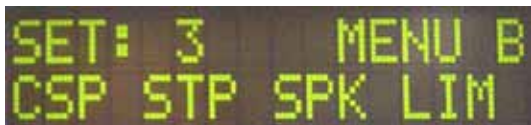



Note

The configured value of the cover slip limit is transferred and saved in all parameter sets (Set 1 through 4) automatically.

5.11.1 Leaving the parameter and submenu



Note

Procedure:

- a) Including saving the previously programmed parameter:
 - Press **RESPOND** once, then press **EXIT**.
- b) Without saving the previously modified parameter:
 - Press **EXIT** once.

After pressing **EXIT**, the instrument is back in a ready-to-start state.

5.12 Recommendation for parameter setting (beginning with firmware 3.01.04)

The following settings serve as recommendations and have to be adapted to the conditions in the respective lab.

The parameter settings have been determined as follows under standardized condition in a Leica Biosystems Nussloch GmbH lab:

- Use of tissue sections with a thickness of 3-5 µm.
- Room temperature: 20-25°C.
- Use of cover slip with a size of 24 x 50 mm and thickness #1.
- Filling level for the loading bath reaches up to the label field of the loaded specimen slide.
- Filling the coverslip mountant bottle with 150-170 ml of coverslip mountant.

The **STP** (starting point for the coverslip mountant stroke) and **CSP** (cover slip placement position) parameters are mentioned only in exceptional cases or not at all.

They have to be adapted on a case-by-case basis.

**Note**

Recommendations for settings for earlier firmware versions (before firmware version 3.01.04) can be requested from your local Leica Biosystems representative.

We recommend using only consumables validated by Leica!

Designation	Manufacturer/ supplier	Loading bath filled with	Dispenser needles	STK	VOL	Type	LEN
CV Mount	Leica	Xylene	20	50	7 (8)	8 (10)	0/
			18	50	5 (6)	4 (5)	-10/
							-20
CV Ultra	Leica	ST Ultra (reagent)	18	50	3/4	5/6	-20
Pertex	Leica/Surgipath	Xylene	18	50	2/3	8	-30
Micromount	Leica/Surgipath	Xylene	18	50	1/2	5/6	<u>0</u>
MM 24	Leica/Surgipath	Xylene	21	40	1/2	4	0
DPX	Leica/Surgipath	Xylene	16	50	9	10	0
Acrytol	Leica/Surgipath	Xylene	20	50	2	5/6	-30/
							-40
Sub-X	Leica/Surgipath	Xylene	20	40	1/2	8	-20/
							-30
Sub-X	Leica/Surgipath	Sub-X Reagent	20	50	1/2	5	-40/
							-50
Clearium	Leica/Surgipath	Empty loading bath/use 2-propanol in the last staining step	21	6	6	0	<u>0</u>
DPX	Merck KGaA	Xylene	18	50	5/6	6	0
Entellan	Merck KGaA	Xylene	20	50	5/6	8	-20
New for robotic coverslippers							
DPX	Fluka	Xylene	18	50	6	6/7	0
Pertex	Medite	Xylene	18	50	7/8	8	0
Mounting Medium No. 4111/4112	Richard-Allen Scientific	Xylene	21	50	1/2	5/6	-30
							-40
Cytoseal Xyl	Richard-Allen Scientific	Xylene	21	50	2/3	5	<u>0</u>
Cytoseal 60 (280)	Richard-Allen Scientific	Xylene	20	50	4/5	6/7	-20
Eukitt	O. Kindler	Xylene	20	50	6	8	0
Histofluid	Marienfeld	Xylene	18	50	7/8	9	0/
							-20
Consul-Mount / Histology Formulation	Shandon/Thermo Scientific	Xylene	18	50	3/4	4	0/
							-20

5 Operation

Designation	Manufacturer/ supplier	Loading bath filled with	Dispenser needles	STK	VOL	Type	LEN
Consul-Mount / Cytology Formulation	Shandon/Thermo Scientific	Xylene	18	50	4/5	6	<u>0</u>
Shandon Xylene Substitute Mountant	Shandon/Thermo Scientific	Xylene	20	50	4/5	5	<u>0</u>
Histokitt II	Carl Roth GmbH	Xylene	20	50	6	7	0
Aquatex: (water based)	Merck KGaA	Distilled water	20	50	7/8	7/8	STP: 40/50 CSP: varies

5.13 Determining the optimum parameter setting (MENU A+B)

① The following procedure provides assistance for:

- Adjusting the previously listed parameter setting to onsite lab conditions.
- Determining the optimum parameter settings for an unlisted coverslip mountant (→ p. 65 – 5.12 [Recommendation for parameter setting \(beginning with firmware 3.01.04\)](#)).
- Changing from coverslipping with solvent ("wet") to coverslipping without solvent ("dry") in the loading bath, or, reversed (→ p. 69 – 3. [Differences between "wet" and "dry" coverslipping](#)).

The following sections give a detailed description of the steps to carry out, from the instrument preparation through to specimen evaluation. During the test series for determining the optimum parameter sets, the coverslipping operation in the instrument should also be observed.

5.13.1 Procedure

1. Filling the coverslip mountant

- It is imperative that there be no air bubbles in the coverslip mountant during parameter setting (use clean bottles; (→ p. 38 – 4.11 [Refilling consumables](#))).

2. Selecting the suitable size or number of dispenser needles (nozzles)

The following are suitable for high-viscosity coverslip mountants:

- Dispenser needle No. 16 (largest diameter),
- Dispenser needle No. 18

The following are suitable for low-viscosity coverslip mountants:

- Dispenser needle No. 21 (smallest diameter),
- Dispenser needle No. 20

The following are suitable for mid-viscosity coverslip mountants:

- Dispenser needle No. 18
- Dispenser needle No. 20

**Note**

Dispenser needle 21 (smallest diameter) => dispenser needle 20 => dispenser needle 18 => dispenser needle 16 (largest diameter).

3. Differences between "wet" and "dry" coverslipping

"Wet" coverslipping with filled loading bath:

- The loading bath must be sufficiently filled with a solvent compatible with the coverslip mountant, i.e. the solvent must extend to the label field of the specimen slide used in the loading bath.

Or:

"Dry" coverslipping with unfilled loading bath:

Note:

- In contrast to "wet" coverslipping, higher application quantities of mountant are necessary for "dry" coverslipping, i.e. the parameters **VOL** and/or **TYP** must be increased as needed.
- If this is no longer possible, a dispenser needle with larger diameter can also be used.

4. Preparing the coverslipping machine

- Be mindful of air-tightness when inserting the coverslip mountant bottle (→ p. 38 – 4.11 Refilling consumables).
- Insert a suitable dispenser needle (→ p. 26 – 4.6 Installing the dispenser group).
- Check the dispenser needle height and adjust as needed (→ p. 29 – 4.7 Aligning the dispenser needle height relative to the specimen slide outfeed).
- Carry out the priming cycle (→ p. 42 – 5.3 Switching the instrument on or off).
- Fill the dispenser needle cleaner, being mindful of the correct seating (→ p. 32 – 4.8 Dispenser needle cleaner (nozzle cleaner)).
- Fill the loading bath with a suitable solvent (→ p. 38 – 4.11 Refilling consumables).
- Fill the cover slip magazine (→ p. 36 – 4.10 Installing the accessories).

5. Important information regarding test run procedure for determining the optimum coverslipping parameters



Note

- The initial coverslipping trials should be carried out with empty specimen slides, i.e. without a specimen.
- If coverslipping quality is good, subsequently carry out a test series using an applied specimen.
- Since factors such as section thickness and specimen composition and type can affect the coverslipping quality, it may be necessary to make minor corrections to the parameter settings.
Ex. **VOL**: Increase or reduction of adjustment by ± 1
and/or **TYP**: Increase or reduction of adjustment by ± 1

6. Evaluation of coverslipping quality

The respective coverslipping quality of the test runs should be checked at various points in time for adhesive and air bubbles:

- Directly after coverslipping operation.
- 1 - 3 hours after coverslipping.
- 24 - 48 hours after coverslipping.

Should air pockets appear between the specimen slide and cover slip after these checks, the settings must be corrected.

If air pockets still occur despite suitable changes, ([→ p. 93 – 8.2 Troubleshooting](#)) provides additional directions.

If artifacts become visible within the monitoring process (streaks, cloudiness, discoloration), the involved reagents must be inspected for compatibility and storage life.

The staining protocol should be adapted as needed.

7. Inputting the first test parameters

7a. Effect of parameters on the application quantity

- **STK** - Stroke length of the coverslip mountant corresponding to the coverslip length used.
- **VOL** - Quantity of the coverslip mountant: 1 (min.) -> 9 (max.)
- **TYP** - Pressure in the mountant bottle: 1 (min.) -> 10 (max.)

7b. Guideline for low-viscosity coverslip mountants

Dispenser needle: 20 or 21 (smallest diameter) **MENU A**:

- **STK**: Adjust stroke length to the cover slip length used (e.g. **STK** = 50 for coverslip size 22 x 50 mm and 24 x 50 mm).
- **VOL**: Start the first coverslip trials with **VOL** set low (approx. 2-4)
- **TYP**: Start the first coverslip trials with **TYP** set low (approx. 2-4)

The parameters **VOL** and **TYP** are incrementally adjusted (increase or reduction) until a suitable application quantity on the specimen slide is attained. Further procedures are described in the following Point (→ p. 71 – 8. Fine-tuning the adhesive and coverslip support positioning).

7c. Guideline for high-viscosity coverslip mountant

Dispenser needle: 18 or 16 (largest diameter) **MENU A:**

- **STK:** Adjust stroke length to the cover slip length used (e.g. **STK** = 50 for coverslip size 22 x 50 mm and 24 x 50 mm).
- **VOL:** Start the first coverslip trials with **VOL** (approx. 5-7)
- **TYP:** Start the first coverslip trials with the setting **TYP** (approx. 5-7)

The parameters **VOL** and **TYP** are incrementally adjusted (increase or reduction) until a suitable application quantity on the specimen slide is attained. Further procedures are described in the following Point (→ p. 71 – 8. Fine-tuning the adhesive and coverslip support positioning).



Note

Important note:

If **TYP** is at the maximum setting (10 - highest pressure), it is possible to generate small air bubbles in the dispenser system. This depends on specific properties of the respective coverslip mountant and the selection of dispenser needle (frequently occurring with small-diameter needles). Therefore it is advisable to begin with the mid-range parameter settings when determining the optimum parameter sets.

Unsuitable procedures:

Dispenser needle No. 21

TYP: 10

VOL: 1 or **2** incremental increase.

Suitable procedures:

Dispenser needle No. 21

TYP: 4 or **5** incremental increase/reduction, with parallel incremental increase/reduction of **VOL**

VOL: 4 or **5** incremental increase/reduction, with parallel incremental increase/reduction of **TYP**

If a suitable coverslip mountant application quantity cannot be attained, switch to a dispenser needle with a different diameter.

8. Fine-tuning the adhesive and coverslip support positioning

Here, the following parameters must be matched to each other:

STP (Stroke position - starting point for the coverslip mountant stroke)

CSP (Cover slip placement position) and

LEN (Stroke length correction for the coverslip mountant stroke)

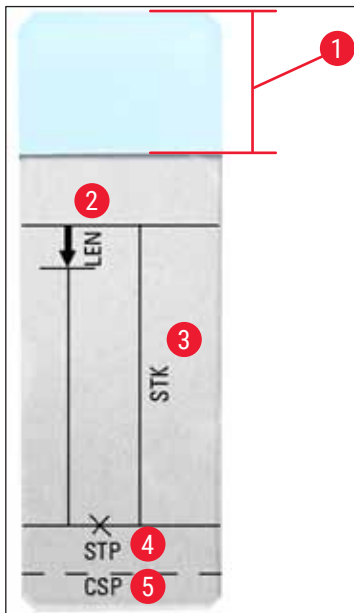

Fig. 45

- 1 Label field
 - 2 **LEN** = STROKE LENGTH CORRECTION
(length correction for the coverslip mountant application)
 - 3 **STK** = MOUNTANT STROKE
(length of the coverslip mountant application)
 - 4 **STP** = STROKE POSITION CORRECTION
(starting point of the coverslip mountant application)
 - 5 **CSP** = COVERSLIP POSITION CORRECTION
(cover slip placement position)
- **STP** and **CSP** must be matched with each other, since otherwise there is the danger that the coverslip mountant could drip over the specimen slide edge into the instrument at the stroke start point, or become stuck to the suction cup due to poor coverslip placement. In both cases, continuing smooth instrument operation cannot be ensured.

Notes on fine-tuning the parameters **STP**, **CSP**, **LEN**

- In most cases, the parameter **STP** must be set in the positive range at approx. +20 to +40 for extremely low-viscosity coverslip mountants (information is based on experimental values and may vary). For lower values (negative value up to 0/+10), there is the danger that the coverslip mountant will flow out over the specimen slide or coverslip edge. On the other hand, if the starting point of the coverslip mountant stroke is still positioned too far towards the specimen slide center, air pockets could form in the coverslip edge area after coverslipping and drying of the coverslip mountant.
- The coverslip placement **CSP** should be positioned before starting the coverslip mountant stroke (in relation to the specimen slide edge, which faces the label field). The settings are to be customized

based on the properties of the coverslip mountant used, whether the coverslipping is "wet" or "dry," and the specimen slide used. If using specimen slides with "clipped corners" (i.e. all four corners are ground off or rounded), take care that the corners do not overlap the cover slip.

If the coverslip placement is not optimal, air bubbles or glued-on material may result at the suction cups.

- The length correction **LEN** shortens the coverslip mountant stroke from the area of the specimen slide label field towards the center of the specimen slide.

If, even though you have the application quantity at a nearly optimal setting (**STK, VOL, TYP**), you identify excess coverslip mountant in the area of the coverslip edge, you can correct this excess by changing the setting for **LEN**.

The application quantity of the coverslipping mountant remains constant during this process. Only the length of the strip of coverslip mountant is shortened. This also makes it possible to correct small bubbles in the area of the coverslip edge near the label field.

6. Workstation operation

6.1 Operation as ST5010 – CV5030 workstation

Both instruments are connected to each other via a **TS5015** Transfer Station.

- Specimen slide holders (→ Fig. 46-3) are conveyed from the unload station (→ Fig. 46-1) into the transfer station by a transfer arm (→ Fig. 46-2).
- The message **STAINER PROC.** appears on the display.

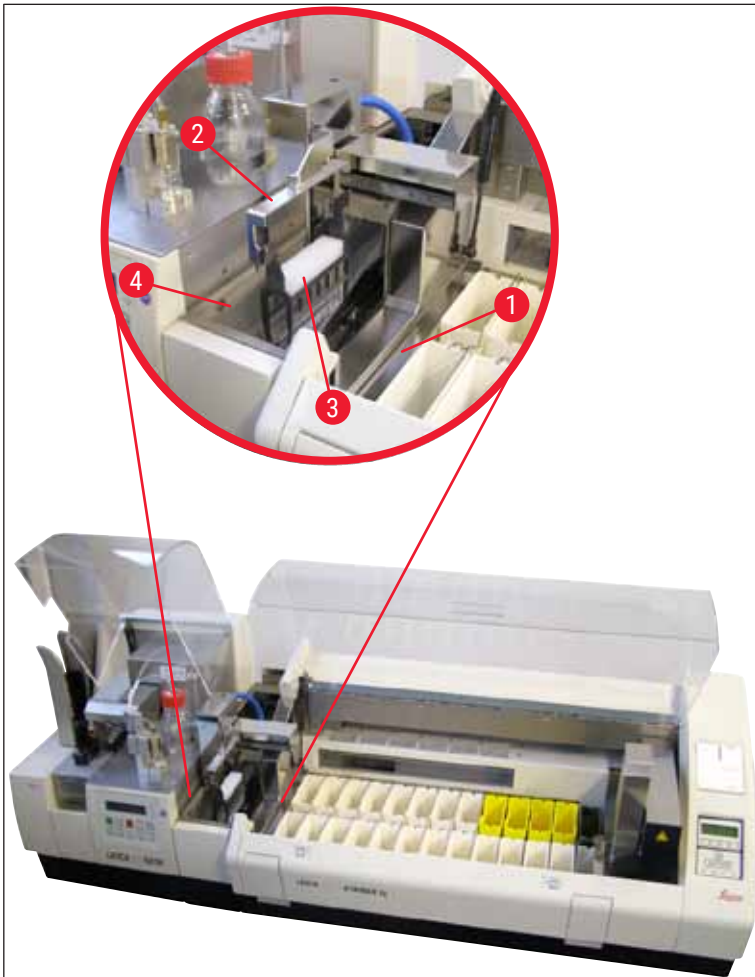

Fig. 46

- Afterwards, the specimen slide holder is transferred to the Leica CV5030, placed in the loading bath and processed.
After the coverslipping operation, the empty specimen slide holder is transferred back onto the discharge chute of the transfer station. The display shows **READY**.
- If the discharge chute is already occupied with two empty specimen slide holders, an additional **TS FULL** message is shown in the display of the Leica CV5030.
- With a third specimen slide holder, the discharge chute is completely occupied and the robotic coverslipper emits a signal tone, accompanied by the messages **TS FULL** and **PAUSED**. The robotic coverslipper is now in pause mode. The specimen slide holders now have to be removed, as otherwise work cannot continue. To do so, confirm the signal tone with the **RESPOND** button.

**Note**

Make sure that the connection between the staining and coverslipping machine is made using the interface cable included in the standard scope of delivery. In addition, when programming the staining protocols, **EXIT** must be entered as the last step. If you do not observe this, the specimen slide holders will **NOT** be transferred into the coverslipper automatically.

- All empty specimen slide holders must be removed from the discharge chute and the drawer of the transfer station must be closed. Then, press the **START** button so that the **READY** message appears on the display. Transfer from the slide stainer to the robotic coverslipper is now possible once again.

Manual loading**Warning**

Basically, we do not recommend manual loading of the Leica CV5030 in workstation operation, as this can impair or stop the program flow of the Leica ST5010 AutoStainerXL.

- However, if it is necessary to insert a specimen slide holder into the loading bath manually for coverslipping, the empty specimen slide holder must also be removed from the loading drawer manually. The empty specimen slide holder is not conveyed automatically into the transfer station and thus onto the discharge chute. Specimen slide holders from the stainer have priority for processing.
- The display shows the **FINISHED** message and a signal tone sounds. Confirm the signal tone with the **RESPOND** button. This is followed by the **PAUSED** and **CHECK BATH** messages and a signal tone. Confirm the signal tone with the **RESPOND** button. The display then shows the **PAUSED** message.
- Do not press the **START** button until after the specimen slide holder is removed. This will ensure that pending specimen slide holders from the slide stainer can be processed.
- If a specimen slide holder is waiting in the unload station of the stainer to be transferred to the Leica CV5030, a manually loaded specimen slide holder cannot be processed.

**Warning**

Ensure that at this time, no specimen slide holder is manually inserted into the loading bath, as this can stop the program flow.

**Note**

So that you do not disturb workstation operation, you should process specimen slide holders that come from the slide stainer first. Only then should you process the specimen slide holders to be loaded manually in the coverslipper.

6.2 Operation as ST5020 – CV5030 workstation

In this case, both instruments are connected to each other by a **TS5025** Transfer Station.

Unlike the Leica ST5010 AutoStainerXL workstation, both instruments - the Leica ST5020 Multistainer and Leica CV5030 - communicate with each other.

6 Workstation operation



Note

There are two interface ports:

The **SERIAL** port (→ Fig. 47-3) has two functions. On the one hand this RS 232 port serves as an intercommunication interface to either the Leica ST5010 (via the transfer station Leica TS5015) or the Leica ST5020 (via the transfer station Leica TS5025). On the other hand it serves as service interface. For you as a customer only the first purpose is allowed for use.

The **RS 485** port (→ Fig. 47-5) serves a pure service interface. Customers are not allowed to use it for any purpose.

- For the communication between the stainer and coverslipper, insert the serial interface cable (→ Fig. 47-4) included in the standard scope of delivery into both instruments using the plug connections (→ Fig. 47-2) (→ Fig. 47-3).
- For this purpose, the socket with the designation **SERIAL** (→ Fig. 47-1) is provided on the rear side of the robotic coverslipper.
- In workstation mode, the robotic coverslipper must be ready to start (**READY**) so that the specimen slides can be processed properly.
- If the Leica CV5030 is not ready to start and requires user intervention, this is indicated by an alarm message on the screen of the Leica ST5020 Multistainer, accompanied by an alarm sound.

Rear side Leica ST5020 Multistainer Rear side Leica CV5030

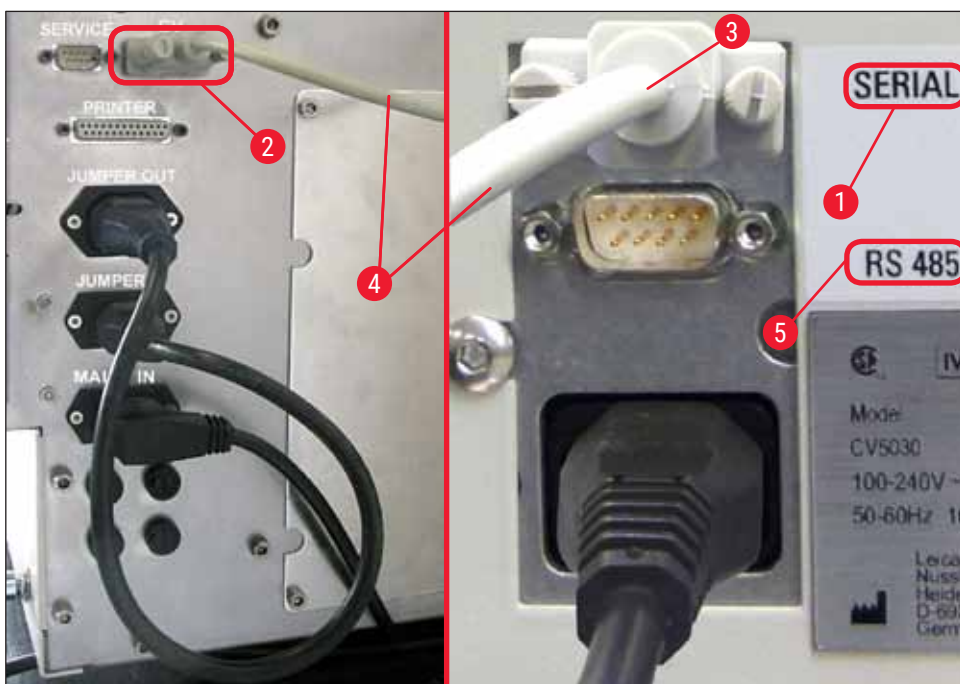

Fig. 47

- From the station programmed last in the staining protocol, the specimen slide holder (→ Fig. 48-1) is removed by the transport arm (→ Fig. 48-5) of the Leica ST5020 Multistainer and conveyed into the TS5025 Transfer Station.
- The transfer arm (→ Fig. 48-5) of the transfer station takes over conveying the specimen slide holder into the loading bath of the robotic coverslipper.
- The message **STAINER PROC** appears on the display.

**Note**

An automatic transport of the specimen slide holders is ensured only if **CV** was programmed in the staining protocols as the last station.

- After the coverslipping operation, the empty specimen slide holder is transferred back onto the discharge chute (→ Fig. 48-4) of the transfer station. The display shows **READY**.
- If the discharge chute is already occupied with two empty specimen slide holders, an additional **TS FULL** message is shown on the display of the Leica CV5030.
- With a third specimen slide holder, the discharge chute is completely occupied and the robotic coverslipper emits a signal tone, accompanied by the messages **TS FULL** and **PAUSED**. The robotic coverslipper is now in pause mode. The specimen slide holders now have to be removed, as otherwise work cannot continue. To do so, confirm the signal tone with the **RESPOND** button. All empty specimen slide holders must be removed from the discharge chute and the drawer of the transfer station must be closed. Then, press the **START** button, so that the **READY** message appears on the display. Transfer from the slide stainer to the robotic coverslipper is now possible once again (→ Fig. 48-1).

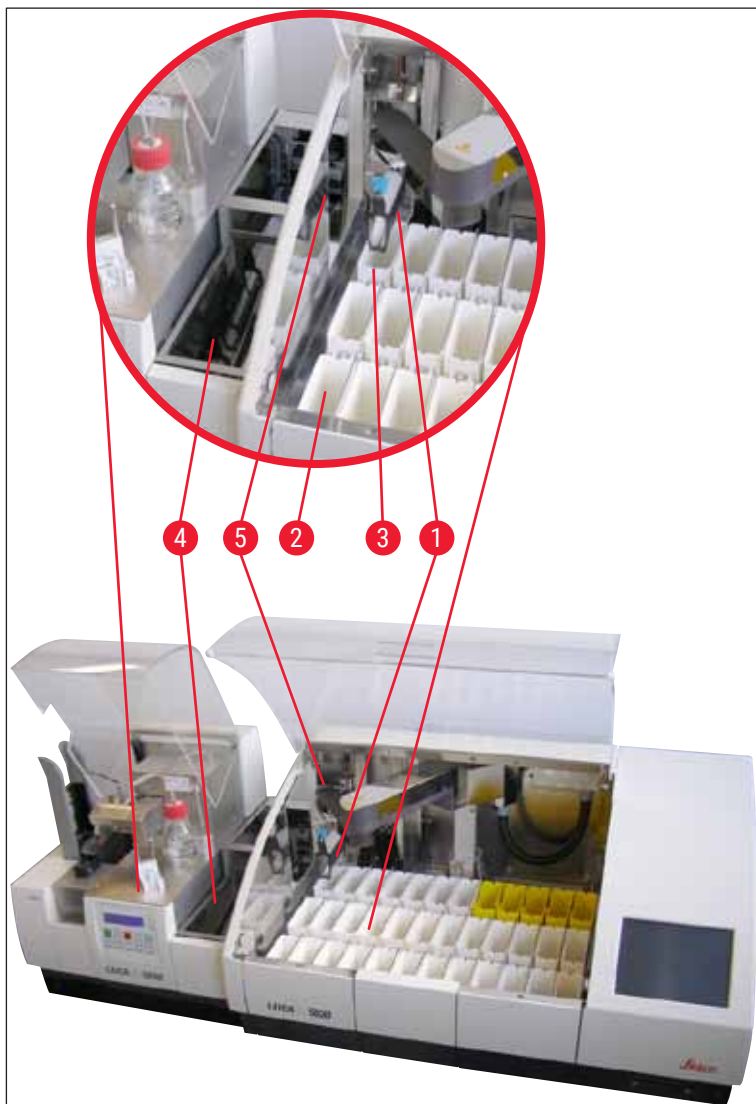

Fig. 48



Warning

Basically, we do not recommend manual loading of the Leica CV5030 in workstation operation, as this can impair or stop the program flow of the Leica ST5020 Multistainer.

- If it is necessary to insert a specimen slide holder into the loading bath manually for coverslipping, the empty specimen slide holder must also be removed from the loading drawer manually. The empty specimen slide holder is not conveyed automatically into the transfer station and thus onto the discharge chute.

6.3 Important instructions for operation as workstation



Note

- Specimen slide holders loaded manually into the Leica CV5030 must always be removed immediately after processing.
- The unloading chute (→ Fig. 49-1) of the transfer stations should be emptied after the **TS FULL** message appears. At the latest, this should be done after a signal tone that occurs after the third specimen slide holder and the **PAUSED** and **TS FULL** messages.
- Ensure that the coverslip magazine in the Leica CV5030 is filled regularly. This will prevent complete emptying of the coverslip magazine, which would cause the robotic coverslipper to stop working and go into pause mode.
- Full output magazines must be removed regularly, as otherwise continuous workstation operation is not guaranteed.

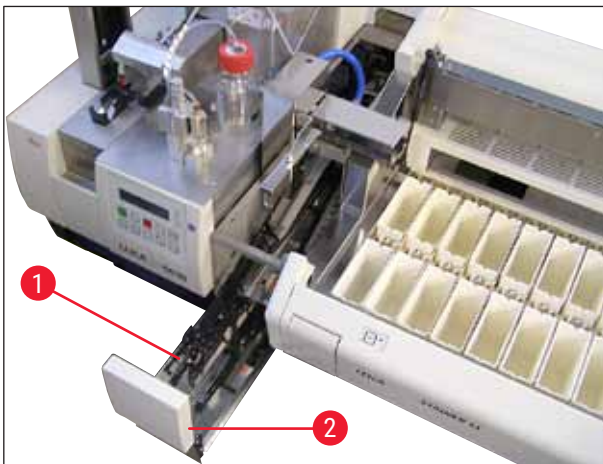

Fig. 49

- The deep bath, which can be identified by side notches (→ p. 103 – Fig. 66), can be used in workstation mode in combination with a silver/**blue** transfer arm (→ Fig. 50-1) only. The transfer arm is in the rear part of the TS5015 / TS5025 Transfer Stations. Before using the deep bath, please check whether the silver/blue transfer arm is available. Older instruments are equipped with a silver/silver transfer arm. The deep bath may not be used in combination with this transfer arm!

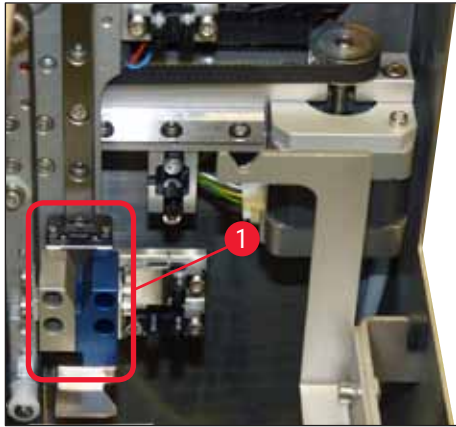

Fig. 50

Important instructions for operation of different specimen slide holders



Note

The default specimen slide holders intended for workstation operation are Leica plastic holders for 30 specimen slides (Order No. 14 0475 33643). Use of other Leica specimen slide holders (e.g. Leica plastic holders for 20 specimen slides) or specimen slide holders from other manufacturers is not permissible in workstation operation. Specimen slide holders from other manufacturers are only permissible when they have been tested on the instrument. These specimen slide holders, or compatible bath inserts, are listed in (→ p. 99 – 9. [Optional Accessories](#)). Impermissible specimen slide holders may in some cases not be recognized by the instrument and a collision may result.

- Apart from workstation operation, the robotic coverslipper can be manually loaded with specimen slide holders from other manufacturers, or with other Leica specimen slide holders, with use of a compatible bath insert only.
- After coverslipping is concluded, ensure that the specimen slide holder is removed once again. Likewise, the replaced bath insert is to be removed before starting a new workstation operation.

6.4 Interrupting workstation operation



- The **PAUSE** and **STOP** buttons have mostly the same functions outlined in (→ p. 48 – 5.6 Interrupting the coverslipping operation).
- If the coverslipping operation is interrupted using the **STOP** button, the coverslipper must be initialized. To do so, press the **START** button.
- After the coverslipping operation is interrupted using the **STOP** button, the specimen slide holder, which is still in the instrument, must be removed from the loading bath manually after processing is finished. In this case, it is not transported automatically back to the transfer station.

**Warning**

If the instrument is operated as a workstation, the user must ensure that before reinitialization, no rack is in the transfer station.

**Note**

So that you do not disturb workstation operation, you should process specimen slide holders that come from the slide stainer first. Only then should you process the specimen slide holders to be loaded manually in the coverslipper.

- In case of power failure or if the instruments are switched off, specimen slide holders can remain in different positions. Therefore, if this error occurs, the following items must be checked:
 - a. Transfer station with all transfer facilities
 - b. Loading bath of the coverslipper
- These specimen slide holders must be removed manually to prevent collisions after resuming workstation operation.
- The specimen slide holders that are left behind must be placed in the coverslipper manually for further processing and removed after processing.

7. Cleaning and Maintenance

7.1 Notes on cleaning and maintenance



Warning

- The instrument should always be cleaned after the end of work, but **BEFORE** the instrument is switched off.
- The regular maintenance intervals must be observed.
- The deep loading bath included in the scope of delivery must be taken out of the instrument **BEFORE** the end of work and not reinserted until after switching on and initialization. This prevents changes to the settings and damage of the gripper.
- Do **NOT** open the gripper by hand! During necessary cleaning measures within the instrument, never alter or tamper with the gripper mechanism for specimen slides. For the red anodized gripper finger, note that it must never be spread, compressed or bent manually. Instead, press the **RELEASE SLIDE** button with the instrument switched on and initialized. This is true for cleaning and maintenance work, after an emergency stop and while the instrument is in operation.
- When using cleaners, please comply with the safety instructions of the manufacturer and the laboratory safety regulations.
- Never use solvents (such as alcohol, acetone, xylene, toluene etc.) or cleaning agents containing solvents to clean the exterior of the instrument.
- Clean the hoods and the housing with mild and pH-neutral commercial household cleaners. The finished surfaces have only limited resistance to solvents!
- Prevent liquids from entering the interior of the instrument or electrical contacts while the instrument is being cleaned or during operation.
- If solvents remain in the unit after it is de-energized, solvent vapors can develop. If the unit is not operated using a vent, danger of fire and poisoning exists!
- Dispose of used reagents while observing applicable local regulations and the disposal regulations of your company/lab.
- After the end of work and before switching off the instrument, we recommend fitting the loading bath filled with solvent with a metal cover (→ p. 17 – 3.3 Standard delivery – packing list) - order No.: 14 0478 39584), removing it from the instrument and placing it separately under a fume hood.
- Switch off the instrument for longer breaks in work and unplug it at the end of the workday.
- During longer breaks and overnight, the dispenser needle must be set into the rest position holder and immersed in the solvent bottle.
- Immediately use a lint-free cloth to wipe off coverslip mountant that drips onto/into the instrument (e.g. during priming or filling a coverslip mountant bottle).
- Make sure that large quantities of solvent are not spilled into the instrument (electronics!). If solvent is spilled, the liquid must be removed using an absorbent cloth immediately.
- Before each maintenance task, remove the loading bath and the specimen slide holder from the instrument, switch the instrument off and unplug it from the power supply.

Notes on cleaning agents



Note

- Clean the hoods and the housing with mild and pH-neutral commercial household cleaners. The finished surfaces have only limited resistance to solvents!
- Clean the cover slip sensors, suction cups, skids of the Pick & Place module, transport chain, specimen slide holder and output magazines using a lint-free cloth soaked in compatible solvent.
- Never leave accessories lying in solvent or water for a long time (e.g. overnight) to prevent damage.

7.2 Daily cleaning and maintenance - overview

- A** Check the loading chute and complete working area of the transport chain for broken glass and adhesive residue. Carefully remove the adhesive residue and broken glass (→ p. 84 – 7.5.1 Loading chute and bath transport with transport chain).
- B** Check the plastic container of the dispenser needle cleaner and, where applicable, refill it with a maximum of 5 ml of a compatible solvent (→ p. 84 – 7.5.2 Dispenser needle cleaner (nozzle cleaner)).
- C** Check the level of the glass vial in the dispenser rest (park) position and, if necessary, fill it with a maximum of 10 ml of a compatible solvent (→ p. 84 – 7.5.3 Glass vial in the dispenser rest position).
- D** Fill the loading bath with a sufficient amount of solvent (→ p. 84 – 7.5.4 Loading Bath).
- E** With the instrument switched on, prime the dispenser needle with coverslip mountant and check the flow. If only a few drops or none at all come out of the dispenser needle, it is blocked and must be exchanged for a new needle of the same type (→ p. 84 – 7.5.5 Dispenser needles). Insert the blocked dispenser needle into a solvent to release the blockage.
- F** Inspect the cover slip catch tray (→ p. 84 – 7.5.6 Cover slip catch tray) and the cover slip magazine (→ p. 84 – 7.5.7 Cover slip magazine) for:
1. Broken glass
 2. Correct seating
- Refill the cover slip magazine if necessary.
- G** Check the Pick & Place module, skids (→ p. 85 – 7.5.8 Skids of the Pick & Place module), suction cups (→ p. 85 – 7.5.9 Cleaning and replacing the suction cups) and cover slip sensor (→ p. 85 – 7.5.10 Cover slip sensor) for:
1. Coverslipping mountant residue
 2. Broken glass
- If necessary, replace the suction cups with new ones and clean the skids using a compatible solvent.
- H** Check the specimen slide outfeed for adhesive residue and, if necessary, clean it using a cloth soaked with compatible solvent (→ p. 86 – 7.5.11 Specimen slide outfeed).

7.3 Weekly cleaning and maintenance

- A** Replace all of the solvent in the loading bath.
- Check the loading bath and loading drawer for broken glass and clean them.
- B** Rinse the dispenser group with solvent (→ p. 86 – 7.6.1 Dispenser group):
1. Fill the second glass bottle (blue cap) with 150 ml of a solvent compatible with the coverslip mountant.
 2. Switch off the instrument, insert the second glass bottle with solvent that is compatible with the coverslipping mountant.
 3. Turn on the instrument and follow the steps described in (→ p. 42 – 5.3 Switching the instrument on or off).
 4. Press the **PRIME** button to rinse the entire dispenser system
 5. Remove the rinsing solvent and reinsert the coverslipping mountant bottle. If necessary, refill fresh coverslip mountant without bubbles.

- C** Check the brush of the dispenser needle cleaner for coverslipping media residue and clean it. Replace any brushes that are very dirty or hard with a new brush (→ p. 86 – 7.6.1 Dispenser group).
- D** Check the dispenser needle, gripper, specimen slide holder and output magazines and clean them with solvent if necessary.
1. Insert the dispenser needle into a suitable, compatible solvent, then clean it carefully with a lint-free cloth (→ p. 87 – 7.6.2 Dispenser needle cleaner (nozzle cleaner)).
 2. Carefully clean the gripper using a lint-free cloth soaked in compatible solvent.
 3. Clean the specimen slide holders and output magazines using a lint-free cloth soaked in compatible solvent (→ p. 87 – 7.6.3 Specimen slide holder, gripper and output magazines). Never soak them in solvent overnight!

**Warning**

- Do **NOT** open the gripper by hand!
- To open the gripper (for cleaning or to remove a gripped specimen slide), press the **RELEASE SLIDE** button. This is true for cleaning and maintenance work, after an emergency stop and while the instrument is in operation.

7.4 Cleaning and maintenance as necessary

- A** Filling the coverslipping mountant bottle:
- If possible, top up the coverslip mountant at the end of the working day so that any air bubbles that arise during filling are degassed by the next working day.
 - The coverslip mountant needs between 6-12 hours of resting time to degas (time depends on the type of the coverslip mountant).
 - If necessary, clean the bottle neck and both O-rings (blue = bottle neck and black = dispenser group) to remove coverslip mountant residue.
- B** • Replace the active carbon filter if necessary, but no later than after three months (→ p. 88 – 7.7.1 Active carbon filter).
- C** Check the transfer station for dirt and clean it if necessary:
- TS5015: Transfer arm (→ p. 89 – 7.7.3 Transfer arm of the TS5015 or TS5025 Transfer Station for workstation operation) and carriage in y-direction.
 - TS5025: Discharge chute (→ p. 88 – 7.7.2 Discharge chute of the TS5015 or TS5025 Transfer Station for workstation operation) and transfer arm.

7.5 Description of the required daily cleaning measures

7.5.1 Loading chute and bath transport with transport chain

- Check the loading chute and bath transport with transport chain for broken glass and adhesive residue and carefully remove any dirt or debris.



Warning

There is a danger of cutting injuries during this cleaning step. Therefore, proceed with the necessary caution.

- Wear protective clothing!

- To clean adhesive residue, use a lint-free cloth soaked in compatible solvent. Loose glass shards and splinters can be cleaned up using a commercially available vacuum cleaner.

7.5.2 Dispenser needle cleaner (nozzle cleaner)

- Fill the dispenser needle cleaner with approx. 5 ml of solvent.
- Check the brush. If the brush is hard or very dirty, replace it with a new brush.

7.5.3 Glass vial in the dispenser rest position

- Check the level, empty if necessary and add a compatible solvent.

7.5.4 Loading Bath

- Fill the loading bath with a sufficient amount of solvent.

7.5.5 Dispenser needles

- Before starting up the instrument and before the priming cycle, check the dispenser needles for proper flow and adhesive residue. Check the dispenser needles to ensure that they are securely in place and not bent (→ p. 26 – 4.6 [Installing the dispenser group](#)).

7.5.6 Cover slip catch tray

- Remove glass residue from the cover slip catch tray. Ensure that the cover slip catch tray is securely in place (→ p. 36 – 4.10 [Installing the accessories](#)).



Warning

Notice: If the cover slip catch tray is not correctly in place, collisions may result.

7.5.7 Cover slip magazine

- Check that the coverslip magazine is correctly seated. Refilling the cover slips can result in broken glass in or below the coverslip magazine, which must be removed.

**Warning**

Notice: If the coverslip magazine is not correctly in place, there may be problems with holding the cover slips during the coverslipping process.

7.5.8 Skids of the Pick & Place module

- Check the skids on the bottom of the Pick & Place module for glued-on material (coverslip mountant with glass shards and splinters) and, if necessary, carefully clean it with a lint-free cloth soaked in compatible solvent.

7.5.9 Cleaning and replacing the suction cups

- Check the suction cups (→ Fig. 51-1) for small glass shards and splinters (from glass breaking) and adhesive residue. Carefully remove any clinging adhesive residue and glass shards and splinters.

**Note**

Carefully wipe down the suction cups using a lint-free cloth soaked in compatible solvent. They must not be allowed to soak in solvent.

- The suction cups have to be replaced if they have visible deformation or damage. To do so, pull the suction cups downwards and off using your fingers (→ Fig. 51) and replace them with new suction cups.



Fig. 51

7.5.10 Cover slip sensor

Check the cover slip sensor (→ Fig. 52-1) for glued-on material and ease of movement:

- The cover slip sensor is located on the bottom of the Pick & Place module, between the two suction cups. The cover slip sensor can be moved freely if it can be moved up and down by tapping it gently with the fingertip.

- If the cover slip sensor cannot be moved and/or you can feel glued-on material, carefully clean the sensor using a lint-free cloth soaked in compatible solvent.



Fig. 52

7.5.11 Specimen slide outfeed

- Check the specimen slide outfeed for adhesive residue and, if necessary, clean it carefully using a lint-free cloth soaked with compatible solvent.

7.6 Description of the required weekly cleaning measures

7.6.1 Dispenser group

We recommend rinsing the dispenser group once a week using approx. 150 ml of a solvent that is compatible with the coverslip mountant.



Warning

Notice: Due to the high pressure when rinsing with solvent, it is necessary to wear gloves, safety goggles and appropriate protective clothing when changing the cover slip mountant! Select an adequately sized container to catch the rinsing residue.

- Switch off the instrument.
- Fill the additional glass bottle included in the standard scope of delivery with 150 ml of solvent.
- If a third glass bottle is needed because the replacement bottle is already filled with coverslip mountant, you can order an additional glass bottle under order No.: 14 0464 36537.
- Unscrew the coverslip mountant bottle and remove it from the instrument.



Warning

Notice: Danger of dripping – any mountant that drips down must be picked up immediately using an absorbent cloth.

- Wipe the coverslip mountant off of the hose end of the dispenser group.
- Insert the replacement bottle filled with solvent into the instrument, screw on the lid to close it correctly (ensure that both O-rings are seated correctly), then switch the instrument back on.
- Wait for the complete initialization to finish, then proceed as for an instrument restart (→ p. 42 – 5.3 [Switching the instrument on or off](#)). However, the priming cycle should be carried out until all of the solvent has been flushed through the dispenser group (press and hold the **PRIME** button).

Filling the coverslipping mountant bottle:

- If possible, top up the coverslip mountant at the end of the working day so that any air bubbles that arise during filling are dissipated by the next working day.
- The coverslip mountant needs between 6-12 hours of resting time to degas (time depends on the type of the coverslip mountant).
- If necessary, clean the bottle neck and both O-rings (blue = bottle neck and black = dispenser group) to remove coverslip mountant residue.

7.6.2 Dispenser needle cleaner (nozzle cleaner)

- Check the brush of the dispenser needle cleaner for dried-on, hardened coverslipping mountant.
- To do so, take the brush out of the plastic container (→ [Fig. 53](#)) and remove clinging coverslip mountant.
- If the brush is very dirty or hard, replace it with a new one.
- Before beginning work, fill the plastic container with 5 ml of solvent. To do so, use the plastic pipettes provided.



Fig. 53

7.6.3 Specimen slide holder, gripper and output magazines

- Carefully clean the gripper using a lint-free cloth soaked in compatible solvent (if necessary, also daily if using labels that protrude or are sensitive to solvent).
- Check the output magazines for clinging and dried coverslipping mountant.
- In particular, dried adhesive residue in the slots of the output magazines can cause problems when inserting the specimen slides.
- Carefully clean the output magazines using a lint-free cloth soaked in compatible solvent.

**Warning**

Notice: The output magazines must not be placed in solvent over a period of multiple hours (e.g. overnight) (→ p. 81 – 7.1 Notes on cleaning and maintenance).

7.7 Description for cleaning and maintenance as necessary**7.7.1 Active carbon filter****Warning**

Active carbon filter not handled appropriately

Serious injury, instrument damage, threat to environment

- Customers are generally allowed to replace an exhausted filter with a new one according to the description in (→ p. 25 – 4.5.1 Inserting the active carbon filter).
- Additionally, safety instructions regarding the absence of voltage in the device as well as local laboratory regulations have to be observed.

**Note**

The active carbon filters provided for the replacement should be stored only unopened and in their undamaged protective plastic bag.

7.7.2 Discharge chute of the TS5015 or TS5025 Transfer Station for workstation operation

Check the discharge chute (→ Fig. 54-1) for dirt and, if necessary, clean it carefully using a lint-free cloth soaked in compatible solvent (→ Fig. 54).

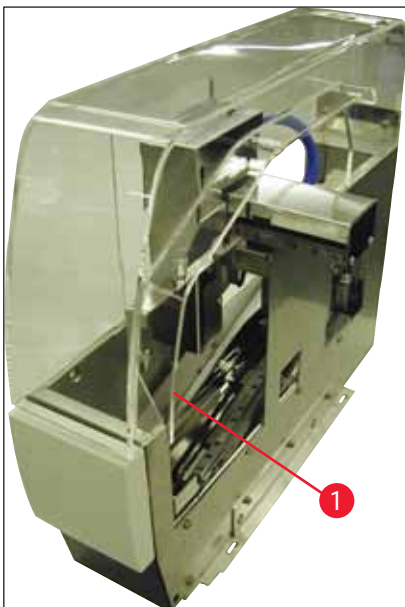

Fig. 54

7.7.3 Transfer arm of the TS5015 or TS5025 Transfer Station for workstation operation

- Check the transfer arm for dirt and, if necessary, clean it carefully using a lint-free cloth soaked in compatible solvent (→ Fig. 55).



Fig. 55

7.8 Procedure for changing the cover slip mountant



Warning

Before switching the mountant, switch off the instrument and disconnect it from the power supply! Remove the loading bath and specimen slide holders from the instrument before switching it off. Due to the high pressure when rinsing with solvent, it is necessary to wear gloves, safety goggles and appropriate protective clothing when changing the cover slip mountant! Select an adequately sized container to catch the rinsing residue.

7.8.1 Changing from one xylene-based coverslip mountant to another

- Remove the mountant bottle.
- Insert a second glass bottle with 150 ml of xylene and rinse/prime it (→ p. 82 – 7.3 Weekly cleaning and maintenance).
- Insert a mountant bottle with the new mountant.
- Run a prime cycle. Hold down the **PRIME** button until the hose is completely free of air bubbles and filled with coverslip mountant.

7.8.2 Changing from a xylene substitute coverslip mountant to a xylene-based mountant



Warning

The sequence of individual substances has to be followed to avoid milky/cloudy clumping in the hose and the dispenser group.

- Remove the mountant bottle.
- Insert a second glass bottle with 150 ml of xylene substitute and rinse/prime it (→ p. 82 – 7.3 [Weekly cleaning and maintenance](#)).
- Empty the second glass bottle and fill it with 150 ml of 100 % ethanol before inserting it and rinsing.
- Empty the second glass bottle and fill it with 150 ml of xylene before inserting it and rinsing/priming.
- Insert a mountant bottle with the new mountant.
- Run a prime cycle. Hold down the **PRIME** button until the hose is completely free of air bubbles and filled with coverslip mountant.

7.8.3 Changing from a xylene-based coverslip mountant to a xylene substitute

- Insert a second glass bottle with 150 ml of xylene and rinse/prime it (→ p. 82 – 7.3 [Weekly cleaning and maintenance](#)).
- Empty the second glass bottle and fill it with 150 ml of 100 % ethanol before inserting it and rinsing.
- Empty the second glass bottle and fill it with 150 ml of xylene substitute before inserting it and rinsing/priming.
- Insert a mountant bottle with the new, substitute-compatible mountant.
- Run a prime cycle. Hold down the **PRIME** button until the hose is completely free of air bubbles and filled with coverslip mountant.



Note

Il parts that were filled with xylene must be converted to the substitute (= loading bath, glass vial, dispenser needle cleaner)!

8. Malfunctions and Troubleshooting

8.1 Error codes



Note

All of the error messages with the corresponding actions for troubleshooting are listed below. If faults occur that cannot be corrected with the procedures recommended in the table, or if they occur again, contact the responsible Leica Service contact person. In case of errors, generally the user's first step is to secure the specimens located at different positions in the instrument/workstation while ensuring personal safety.

Display	Cause	Troubleshooting
Error 301 SLIDER BLOCKED	The specimen slide outfeed is blocked.	Check the specimen slide outfeed (→ p. 86 – 7.5.11 Specimen slide outfeed) and output magazine (→ p. 87 – 7.6.3 Specimen slide holder, gripper and output magazines). Remove the cause of the blockage (glued-on material due to coverslip mountant residue) if necessary (→ p. 87 – 7.6.3 Specimen slide holder, gripper and output magazines). Switch the instrument off and back on and proceed as described in (→ p. 42 – 5.3 Switching the instrument on or off).
Error 305 GR-X BLOCKED	The horizontal movement of the gripper tongs is blocked.	Remove the cause of the blockage. If the gripper tongs have gripped a specimen slide, use RELEASE SLIDE to open the gripper tongs and manually remove the specimen slide. Then switch the instrument off and on and proceed as described in (→ p. 42 – 5.3 Switching the instrument on or off). Ensure that any adhesive residue has been cleaned from the gripper jaws (adhesive from leftover labels sensitive to solvents) (→ p. 87 – 7.6.3 Specimen slide holder, gripper and output magazines).
Error 306 GR-Z BLOCKED	The gripper is blocked in its vertical movement.	Remove the cause of the blockage. If the gripper tongs have gripped a specimen slide, use RELEASE SLIDE to open the gripper tongs and manually remove the specimen slide. Then switch the instrument off and on and proceed as described in (→ p. 42 – 5.3 Switching the instrument on or off).

Display	Cause	Troubleshooting
Error 312 TS-X BLOCKED	The transfer arm of the TS5025/5015 Transfer Station is blocked in its left/right movement (X-axis).	Remove the cause of the blockage (specimen slide holder) and inspect the transfer arm of the TS5025/TS5015. Remove empty specimen slide holders from the discharge chute of the transfer station. Switch the instrument off and on. Proceed further as described in (→ p. 42 – 5.3 Switching the instrument on or off). Place any removed specimen slide holders into the coverslipper and have them coverslipped (thus outside of the workstation operation).
Error 313 TS-Z BLOCKED	The transfer arm of the TS5025/5015 Transfer Station is blocked in its up/down movement (Z-axis).	Remove the cause of the blockage (specimen slide holder) and inspect the transfer arm of the TS5025/TS5015. Remove empty specimen slide holders from the discharge chute of the transfer station. Switch the instrument off and on. Proceed further as described in (→ p. 42 – 5.3 Switching the instrument on or off). Place any removed specimen slide holders into the coverslipper and have them coverslipped (thus outside of the workstation operation).
Error 314 TS-AX BLOCKED	The gripper of the TS5015 Transfer Station is blocked in its left/right movement (X-axis).	Remove the cause of the blockage (specimen slide holder) and inspect the gripper of the TS5015. Remove empty specimen slide holders from the discharge chute of the transfer station. Switch the instrument off and on. Proceed further as described in (→ p. 42 – 5.3 Switching the instrument on or off). Place any removed specimen slide holders into the coverslipper and have them coverslipped (thus outside of the workstation operation).
Error 315 TS-AY BLOCKED	The carriage of the TS5015 Transfer Station is blocked in its forward/backward movement (Y-axis).	Remove the cause of the blockage (specimen slide holder) and inspect the carriage of the TS5015. Remove empty specimen slide holders from the discharge chute of the transfer station. Switch the instrument off and on. Proceed further as described in (→ p. 42 – 5.3 Switching the instrument on or off). Place any removed specimen slide holders into the coverslipper and have them coverslipped (thus outside of the workstation operation).

Display	Cause	Troubleshooting
Error 316 TS-AZ BLOCKED	The gripper of the T5015 Transfer Station is blocked in its up/down movement (Z-axis).	Remove the cause of the blockage (specimen slide holder) and inspect the gripper of the TS5015. Remove empty specimen slide holders from the discharge chute of the transfer station. Switch the instrument off and on. Proceed further as described in (→ p. 42 – 5.3 Switching the instrument on or off). Place any removed specimen slide holders into the coverslipper and have them coverslipped (thus outside of the workstation operation).
Error 319 CS SENSOR DEF.	The cover slip sensor is stuck or defective.	Clean the Pick & Place module and the cover slip sensor using a lint-free cloth soaked in compatible solvent as described in (→ p. 85 – 7.5.10 Cover slip sensor).
Error 322 CONFIG FAULT	The reference values of the instrument are faulty.	Contact Leica Service.

8.2 Troubleshooting

Problem	Possible cause	Remedy
Air bubbles (between specimen and cover slip).	Air bubbles have developed in the coverslip mountant from filling the coverslip mountant bottle.	<p>Observe the coverslip mountant's idle time of approx. 6 to 12 hours after filling the mountant bottle.</p> <p>Make sure that the coverslip mountant bottle is filled carefully.</p> <p>Before the instrument is restarted, check whether the coverslip mountant is moved out of the dispenser needle during the priming cycle without bubbles.</p> <p>At the same time there must not be any more air bubbles in the hose of the dispenser group (apply coverslip mountant on an empty specimen slide to check).</p>
Air bubbles (between specimen and cover slip).	Height of the dispenser needle is set incorrectly.	Set the needle height correctly (→ p. 30 – 4.7.2 Setting the needle height). Check the dispenser needle to see if it is clogged by glued-on material or bent.
Air bubbles (between specimen and cover slip).	The dispenser needle is partially clogged by glued-on material or otherwise blocked.	<ol style="list-style-type: none"> 1. Clean the dispenser needle: 2. Remove the needle from the dispenser and leave it in a compatible solvent overnight. 3. To resume working on the instrument, insert a new needle of the same size and carry out a sufficiently long priming cycle before the next coverslipping operation. 4. When reinserting the dispenser needle, always check the needle height. 5. Check the dispenser needle cleaner: 6. Fill this daily with sufficient solvent. Replace the brush of the dispenser needle cleaner if it has glued-on material and/or hardening.

Problem	Possible cause	Remedy
Air bubbles (between specimen and cover slip).	Dispenser needle is bent.	<ol style="list-style-type: none"> 1. Insert a new dispenser needle of the same size and carry out a sufficiently long priming cycle before the next coverslipping operation. 2. When reinserting the dispenser needle, always check the needle height. 3. Check the dispenser needle cleaner: Fill this daily with sufficient solvent. Replace the brush of the dispenser needle cleaner if it has glued-on material and/or hardening.
Air bubbles (between specimen and cover slip).	Glued-on material within the dispenser group.	Glued-on material from hardened coverslip mountant in the dispenser group usually cannot be seen. If air bubbles continue to form despite carrying out the actions mentioned above, rinse the dispenser group with 100 ml of a compatible solvent. Do so in accordance with the instructions in (→ p. 81 – 7. Cleaning and Maintenance).
Air bubbles (between specimen and cover slip).	The dispenser needle diameter has not been selected appropriately for the coverslip mountant used.	The size of the dispenser needle has to be selected according to the list of recommendations (→ p. 65 – 5.12 Recommendation for parameter setting (beginning with firmware 3.01.04)) of the various coverslip mountants or be determined as described in the configuration recommendations.
Air bubbles (between specimen and cover slip).	The air bubbles are produced by leaks in the hose system of the dispenser group.	If there is a leak in the hose system that cannot be remedied, notify the responsible Leica Service.
Air bubbles (between specimen and cover slip).	The coverslip mountant is incompatible with the solvent used.	<p>Make sure that a solvent compatible with the coverslip mountant is used in the loading bath of the CV5030 as well as in the last steps of the preceding dyeing process.</p> <p>If commercially available coverslip mountant is diluted with a solvent that is incompatible, this can also cause small air bubbles.</p> <p>Incompatibility can frequently be identified by striation.</p>
Air bubbles (between specimen and cover slip).	The suction cups of the Pick & Place module have become stuck or deformed.	<p>Non-functional suction cups impede coverslip placement. Check the suction cups for glued-on material and deformation and replace them if necessary.</p> <p>If material has become glued-on because of incorrectly configured parameters (such as too much coverslip mountant), these have to be checked and readjusted.</p>

Problem	Possible cause	Remedy
No coverslip mountant is applied to the specimen slide.	<ol style="list-style-type: none"> 1. The dispenser needle is completely clogged. 2. The plug (→ Fig. 10-4) is detached. 	<ol style="list-style-type: none"> 1. The dispenser needle is partially or completely clogged by dried coverslip mountant. Replace the clogged needle with a new one of the same size. 2. Insert the plug.
Coverslip mountant is applied over the entire length of the specimen slide, including the label field.	<ol style="list-style-type: none"> 1. Height of the dispenser needle is set incorrectly. 2. The dispenser needle diameter has not been selected appropriately for the coverslip mountant used. 3. The coverslipping parameters are incorrect. 	<ol style="list-style-type: none"> 1. Set the height of the dispenser needle correctly. 2. and 3. The dispenser needle size and coverslipping parameters have to be selected in accordance with the list of recommendations of various coverslip mountants (→ p. 65 – 5.12 Recommendation for parameter setting (beginning with firmware 3.01.04)) or be determined as in (→ p. 68 – 5.13 Determining the optimum parameter setting (MENU A+B)).
The specimen gets damaged when coverslip mountant is applied.	The height of the dispenser needle is set incorrectly or the dispenser needle was inserted incorrectly.	The height of the dispenser needle is set too low, so that it scratches the specimen when coverslip mountant is being applied. The height of the dispenser needle has to be readjusted to the correct height (→ p. 29 – 4.7 Aligning the dispenser needle height relative to the specimen slide outfeed).

**Note**

Notice! Make sure the dispenser needle is securely in place (clamp is in the retaining plate).

Problem	Possible cause	Remedy
The cover slips have been deposited on the specimen slide incorrectly.	1. The cover slip magazine is inserted incorrectly.	1. Check how the coverslip magazine is seated; remove any dirt or remnants of glass from in/under the coverslip magazine.
	2. The cover slips stick to each other.	2. Use cover slips of sufficient quality and store them in a dry place.
	3. The cover slip sensor is dirty.	3. Check the cover slip sensor for dirt; if necessary, clean the sensor with a cloth soaked in compatible solvent.



Warning

Attention! If the actions described above do not remedy the problem that has occurred, contact the responsible Leica Service.

The cover slips have been deposited on the specimen slide at the incorrect position.	1. The cover slips have been inserted into the coverslip magazine incorrectly.	1. The cover slips have to be flush against the edge of the front side in the coverslip magazine.
	2. The parameter CSP has been selected incorrectly.	2. The parameter CSP (coverslip position = cover slip placement position) has to be corrected. In addition, it may be necessary to modify the parameter STP (stroke position = starting point of the coverslip mountant stroke) (→ p. 59 – 5.10 MENU A – parameter settings).
Intact cover slips are conveyed into the cover slip catch tray.	1. The cover slip sensor is dirty.	1. Check the cover slip sensor for dirt; if necessary, clean the sensor with a lint-free cloth soaked in compatible solvent.
	2. The suction cups are deformed.	2. Replace the suction cups.

Problem	Possible cause	Remedy
The coverslip mountant is not evenly distributed.	The dispenser needle is clogged by dried coverslip mountant or dried coverslip mountant has accumulated around the dispenser needle.	Replace the dispenser needle with a new one. Place the clogged dispenser needle in xylene or another, corresponding solvent overnight and then carefully clean it of residual mountant.
The Pick & Place module collides with the coverslip magazine or there is a scraping noise when lifting the cover slip.	The cover slip magazine is inserted incorrectly.	Check whether dirt, such as broken glass, is on the floor and/or in the holder of the cover slip magazine; if necessary, carefully remove them.
The display shows the CHECK SLIDES message and no specimen slides are gripped.	<ol style="list-style-type: none"> 1. Low-quality specimen slides were used. 2. Specimen slides or specimen slide holders have been damaged and the instrument cannot detect them. 	<ol style="list-style-type: none"> 1. Make sure that the loading bath is completely filled with solvent for "wet" coverslipping. Check the liquid level and refill if necessary. 2. If the maximum fill level is not enough to cover the tissue samples completely, the deep loading bath received in the standard delivery has to be used. Loading bath, deep – Order No.: 14 0478 39657



Note

Notice! When using the deeper loading bath in workstations (Leica ST5010 AutoStainerXL or Leica ST5020 Multistainer), take into account that a corresponding technical modification is necessary when using older models or upgrading a workstation. Contact the responsible Leica service for this purpose.

Problem	Possible cause	Remedy
The specimen slide holders do not fit into the bath insert.	<ol style="list-style-type: none"> 1. The bath inserts or specimen slide holders are dirty, bent or inserted into the loading bath incorrectly. 2. Specimen slide holders from other manufacturers are used, which are incompatible with the bath inserts used. 	<ol style="list-style-type: none"> 1. Check whether the bath inserts or specimen slide holders are correctly inserted in the loading bath. If necessary, carefully remove any existing dirt or broken glass. 2. Use bath inserts compatible with the specimen slide holder (→ p. 99 – 9.1 Ordering information).
The loading bath does not move forward; the transport chain does not move.	There is a (mechanical) obstacle in the transport area.	<p>The transport mechanism consists of a chain module on the floor of the loading drawer.</p> <p>Check whether the chains move if the loading drawer is pulled out. If not, the chains may be blocked, for example, by glass shards and splinters or dried-on coverslip mountant. Likewise, check whether there are pieces of broken glass or specimen slides clinging to the bottom of the loading bath.</p> <p>Clean the transport area with a suitable solvent, such as xylene.</p> <p>If the chain mechanism does not function even after being cleaned, contact the responsible Leica Service.</p>

9. Optional Accessories

9.1 Ordering information



Note

To prevent damage to the instrument or specimens, only accessories and spare parts authorized by Leica may be used.

Designation	Order No.
Dispenser needle, 21G	14 0478 40157
Dispenser needle, 20G	14 0478 40158
Dispenser needle, 18G	14 0478 40159
Dispenser needle, 16G	14 0478 40160
Dispenser needle cleaner set, large	14 0478 40941
Dispenser needle cleaner set, small	14 0478 40559
Dispenser needle brush, 5 pieces	14 0478 41115
Cover slip catch tray	14 0478 39585
Output magazine 30, 4 pieces	14 0478 39586
Output magazine 20, 6 pieces	14 0478 40117
Loading bath specimen slide, flat, optional (for instruments with a serial No. lower than 3472)	14 0478 39592
Loading bath for specimen slide holder, deep	14 0478 39657
Cover for loading bath	14 0478 39584
Cover with cutout for loading baths	14 0478 40337
Coverslip mountant bottle with cover	14 0464 36537
O-ring 28x3 mm, 5 pieces	14 0253 45452
Coverslip magazine, 40-60x24 mm	14 0478 39749
Coverslip magazine, 40-60x22 mm	14 0478 39748
Exhaust air hose ID32 mm	14 0478 39820
Glass vial with cover	14 0478 39789
Suction cup, 2 pieces	14 0478 39701
Specimen slide holder 20, Type Sakura, plastic	14 0474 33463
Specimen slide holder 30, Type Leica, metal, 1 piece	14 0456 33919
Specimen slide holder 20, Type Leica, metal, 1 piece	14 0474 32789
Specimen slide holder 30, plastic, 5 pieces	14 0475 33643
Specimen slide holder 30, plastic, 1 piece	14 0475 33750
Specimen slide holder 30, mod. Leica, plastic	14 0478 38029
Kit Adapter Rack 30 HistoCore SPECTRA ST	14 0478 55522
Kit Clip Rack 30 HistoCore SPECTRA ST	14 0478 55510
Adapter Rack 30 HistoCore SPECTRA ST	14 0478 54396
Varistain adapter for Varistain 24-2	14 0464 37659
Adapter for DRS601/Varistain XY	14 0464 37058
Bath insert for Leica specimen slide holder for 30 specimen slides	14 0478 39593
Bath insert for Leica specimen slide holder for 20 specimen slides	14 0478 36706

Designation	Order No.
Bath insert for specimen slide holder 20, Leica Sakura Type	14 0478 36707
Bath insert Shandon 20	14 0478 36709
Bath insert Medite/Hacker 20	14 0478 36710
Bath insert Medite/Hacker 30	14 0478 37263
Bath insert Medite/Hacker 20/40	14 0478 39781
Leica TS5025 Transfer Station	14 0478 39710
Leica TS5015 Transfer Station	14 0506 38050
Baseplate for workstation	14 0475 37647
CV Mount, 4 bottles, 250 ml ea., in carton	14 0464 30011
Coverslipping mountant for all common coverslipping machines and manual coverslipping.	
Leica ST Ultra, 1 canister, 10 liters	14 0709 36260
Leica ST Ultra intermedium was developed as a xylene substitute for histological specimen mounting, removal of paraffin from specimens, and manual as well as automated specimen coverslipping. ST Ultra can be used for specimen coverslipping only together with Leica CV Ultra.	
Leica CV Ultra, 1 bottle, 250 ml	14 0709 37891
Leica CV Ultra, 6 bottles, ea. 100 ml, in carton	14 0709 36261
Coverslipping mountant for all common coverslipping machines and manual coverslipping. Xylene-free.	



Note

Leica provides no warranty for the function of specimen slide holders from other manufacturers or any warranty for their function in the instrument. The instrument operator bears responsibility for any use of specimen slide holders from other manufacturers!

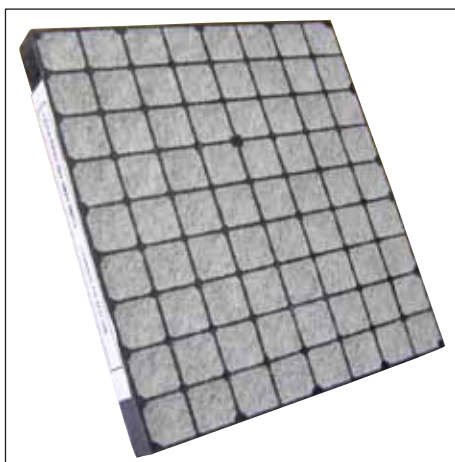

Fig. 56

Standard active carbon filter,
for working with xylene

Order No. 14 0422 30673



Fig. 57

Cover slips,

of pure white glass of hydrolytic class 1, thickness No. 1 (0.13 – 0.17 mm)

Supply quantity:

1000 pieces – in plastic boxes, each with 100 pieces.

Order No.

Size 24x40 mm	14 0711 35635
Size 24x50 mm	14 0711 35636
Size 24x55 mm	14 0711 35637
Size 24x60 mm	14 0711 35638

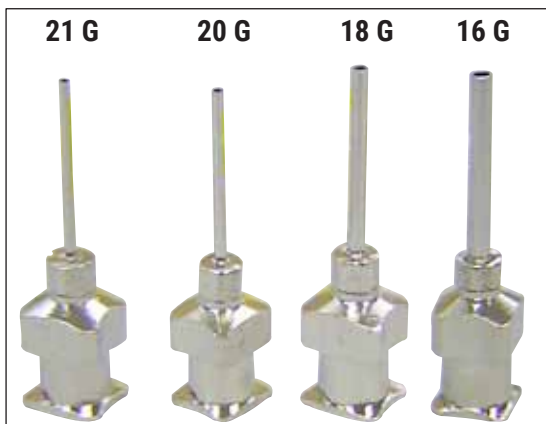

Fig. 58

Dispenser needle,

Order No.

21 G, extra small, 1 piece	14 0478 40157
20 G, small, 1 piece	14 0478 40158
18 G, large, 1 piece	14 0478 40159
16 G, extra large, 1 piece	14 0478 40160

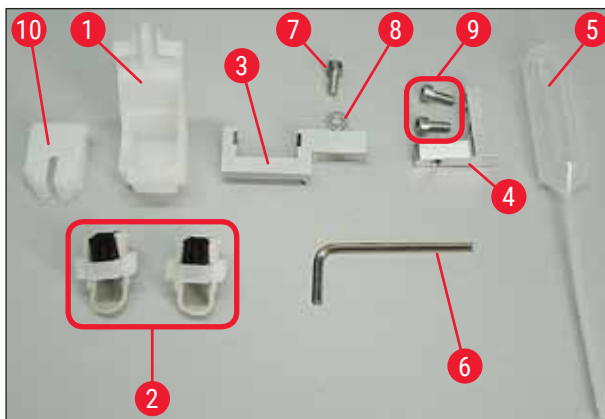

Fig. 59

Dispenser needle cleaner, assembly

Dispenser needle cleaner consisting of:

- 1 container (→ Fig. 59-1) with lid (→ Fig. 59-10)
- 2 brushes (→ Fig. 59-2)
- 1 holder (→ Fig. 59-3) with hexagon socket screw (→ Fig. 59-7) and shim (→ Fig. 59-8)
- 1 mounting bracket (→ Fig. 59-4) with 2 hexagon socket screws (→ Fig. 59-9)
- 1 hexagon spanner (→ Fig. 59-6)
- 1 plastic pipette (7.7 ml) (→ Fig. 59-5)
- 1 set of Instructions for Use

Order No.

14 0478 40941



Fig. 60

Dispenser needle cleaner, small

Set consisting of:

- Container
- Cover
- Brush

Order No. 14 0478 40559



Fig. 61

Dispenser brush

Set of 5

Order No. 14 0478 41115



Fig. 62

Cover slip catch tray

Order No. 14 0478 39585



Fig. 63

Output magazine 30,
for 30 specimen slides, 4 pcs.

Order No. 14 0478 39586



Fig. 64

Output magazine 20,
for 20 specimen slides, 6 pcs.

Order No. 14 0478 40117



Fig. 65

Loading bath for specimen slide holder,
flat

Order No. 14 0478 39592

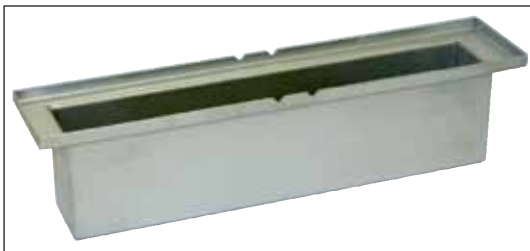

Fig. 66

Loading bath for specimen slide holder,
deep

Order No. 14 0478 39657



Fig. 67

Cover for loading bath

Order No. 14 0478 39584



Fig. 68

Cover with cutout,
for loading bath, only together with bath insert
for Leica specimen slide holder for 30 specimen
slides - 14 0478 39593

Order No. 14 0478 40337



Fig. 69

Glass bottle with cover,

bottle for coverslipping mountant, volume 250 ml, empty, with cover

Order No. 14 0464 36537



Fig. 70

Cover slip magazine,

coverslip magazine Multi-size™ with inserts for holding various common coverslip sizes

40-60x22 mm

Order No. 14 0478 39748

40-60x24 mm

Order No. 14 0478 39749



Fig. 71

Exhaust hose,

solvent-resistant, flexible, 3 m length, diameter 32 mm

Order No. 14 0478 39820



Fig. 72

Glass vial with cover

Order No. 14 0478 39789



Fig. 73

**Suction cups,
pack of 2**

Order No. 14 0478 39701

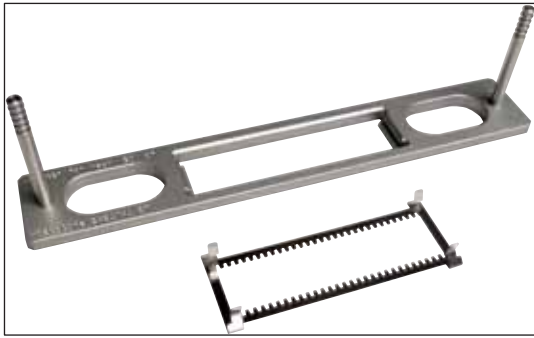

Fig. 74

Kit Adapter Rack 30 HistoCore SPECTRA ST,

for Leica specimen slide holders for 30 specimen slides.

Consisting of:

1 Adapter

1 Clip

Order No. 14 0478 55522

Kit Clip Rack 30 HistoCore SPECTRA ST,

Consisting of 2 Clips

Order No. 14 0478 55510

Adapter Rack 30 HistoCore SPECTRA ST,

for Leica specimen slide holders for 30 specimen slides.

Order No. 14 0478 54396

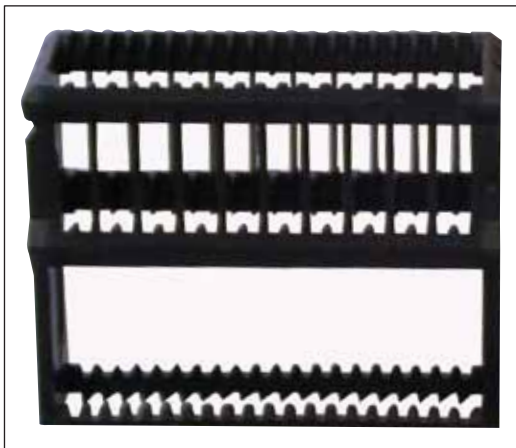

Fig. 75

Sakura specimen slide holder,

Type: Sakura plastic, 1 piece

**Note**

When used together with ST4040, use transport clip 14 0474 34969.

Order No. 14 0474 33463



Fig. 76

Specimen slide holder 30,

Plastic, pack of 5
33643

Order No. 14 0475

Plastic, 1 Pc.
33750

Order No. 14 0475



Fig. 77

Specimen slide holder 30,

Modified, plastic, 1 piece, for Varistain adapter
(14 0464 37659)

Order No.

14 0478 38029



Fig. 78

Varistain adapter,

Adapter for Shandon Varistain 24-4,



Note

For use with Leica specimen slide holder 30, modified, plastic 14 0478 38029, to combine Varistain 24-4 with Leica CV5030.

Order No.

14 0464 37659



Fig. 79

Bath insert Leica 20,

for Leica specimen slide holders, for 20 specimen slides

Order No. 14 0478 36706



Fig. 80

Bath insert Sakura 20,

for Sakura specimen slide holders, for 20 specimen slides

Order No. 14 0478 36707



Fig. 81

Bath insert Shandon 20,

for Shandon Gemini, specimen slide holder for 20 specimen slides

Order No. 14 0478 36709

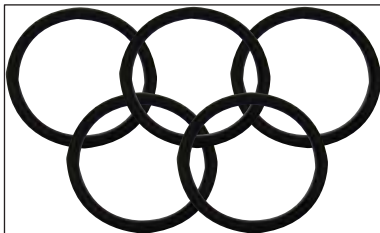

Fig. 82

O-ring,

for mountant bottle, 28x3 mm, pack of 5

Order No. 14 0253 45452

10. Warranty and Service

Warranty

Leica Biosystems Nussloch GmbH guarantees that the contractual product delivered has been subjected to a comprehensive quality control procedure based on the Leica in-house testing standards, and that the product is faultless and complies with all technical specifications and/or characteristics warranted.

The scope of this warranty is determined by the contents of the contract that has been concluded. The warranty terms of your Leica sales organization or the organization from which you have purchased the contractual product shall apply exclusively.

Service information

If you are in need of technical customer support or spare parts, please contact your Leica representative or the Leica dealer where you purchased the instrument. Please provide the following information:

- Model name and serial number of the instrument.
- Location of the instrument and name of a contact person.
- Reason for the service call.
- Delivery date.

Shutdown and disposal of the instrument

The instrument or parts of the instrument must be disposed of according to existing applicable, local regulations.

11. Decontamination Confirmation

Every product that is returned to Leica Biosystems or that requires on-site maintenance must be properly cleaned and decontaminated. You can find the dedicated template of the decontamination confirmation on our website www.LeicaBiosystems.com within the product menu. This template has to be used for gathering all required data.

When returning a product, a copy of the filled and signed confirmation has to be enclosed or passed on to the service technician. The responsibility for products that are sent back without this confirmation or with an incomplete confirmation lies with the sender. Returned goods that are considered to be a potential source of danger by the company will be sent back at the expense and risk of the sender.

12. Appendix A – Application-related notes and recommendations

12.1 Leica specimen slide holders, output and coverslip magazines made of plastic

Leica plastic accessories are manufactured from special material and designed for long-term use.

Various factors, such as material-dependent aging, material fatigue conditioned by use, heat and dirt can lead to the changes in the plastic.

Therefore Leica specimen slide holders and output magazines are among the after-sales parts and listed under Optional Accessories (→ p. 99 – 9. [Optional Accessories](#)).

In order for the plastic accessories to be able to be used as long as possible, we have put together some notes, which are recommended for the following specimen slide holders as well as output and coverslip magazines:

- Output magazine for 30 specimen slides (14 0478 39586)
- Output magazine for 20 specimen slides (14 0478 40117)
- Specimen slide holder for 30 specimen slides, Type Leica, plastic (14 0475 33750)
- Specimen slide holder for 20 specimen slides, Type Sakura, plastic (14 0474 33463)
- Specimen slide holder for 30 specimen slides, Type Leica, modified, plastic, for Varistain adapter (14 0478 38029)
- Coverslip magazine for cover slips 40-60x24 mm (14 0478 39749)
- Coverslip magazine for cover slips 40-60x22 mm (14 0478 39748)



Note

Never store Leica plastic accessories for a long time (for example, overnight for cleaning purposes) in solvent or at high temperatures!

For the **output magazines** to function flawlessly, avoid deformation of the side panels of the output magazines.

- The output magazines must not be placed in solvent over a period hours (e.g. overnight) (→ p. 81 – [7.1 Notes on cleaning and maintenance](#)).
- No drying after contact with solvent or water at temperatures over 100°C and a long time (e.g. overnight).

For the **specimen slide holders** to function flawlessly, avoid the following:

- The specimen slide holders must be handled carefully. Do not let them fall or collide with other objects, which could result in fracture points that can impair the function of the specimen slide holders.
- Avoid drying after contact with solvent or water at temperatures over 100°C and a long time (e.g. overnight).

For the **coverslip magazines** to function flawlessly, avoid the following:

- No drying after contact with solvent or water at temperatures over 100°C and a long time (e.g. overnight).

12.2 Specimen slide holders from other manufacturers

Leica provides no warranty for the function of specimen slide holders from other manufacturers or any warranty for their function in the instrument. The instrument operator bears responsibility for any use of specimen slide holders from other manufacturers.

- The use of specimen slide holders from other manufacturers requires special bath inserts, which are listed under Optional Accessories.
- We recommend just as regularly inspecting the specimen slide holders from other manufacturers for damage, dirt and deformation. These factors in conjunction with the particular construction of the specimen slide holders from other manufacturers can jeopardize smooth function in the instrument. Therefore, particularly when using specimen slide holders from other manufacturers, make sure that they are in flawless condition.

12.3 Specimen slides and gripper mechanism

The new gripper mechanism and the new specimen slide gripper can be identified by the red anodized gripper fingers. This change applies beginning with **SERIAL NUMBER 3000** for the Leica CV5030.



Warning

Notice! The gripper mechanism for the specimen slides is never allowed to be changed or manipulated during necessary cleaning measures within the instrument. With regard to the red anodized gripper fingers, make sure that they are never manually spread, pressed together or bent.

The new gripper mechanism is suitable for all specimen slides that have been manufactured in accordance with ISO 8037-1:1986 and have the following edge properties:

- 1.) 90° ground
- 2.) 90° cut
- 3.) 45° ground
- 4.) Mounted edges (ground or prism-shaped)
- 5.) Clipped corners with the above-mentioned edge properties

12.4 Leica CV5030 – Validated and recommended specimen slides

Name	Manufacturer	Properties and description
Snowcoat	Leica - Surgipath	Ground edges 90°
Snowcoat	Leica - Surgipath	Ground edges 45°
Snowcoat	Leica - Surgipath	Clipped corners
Snowcoat Pearl	Leica - Surgipath	Ground edges 90°
X-tra Slides	Leica - Surgipath	Ground edges 90° Clipped corners
X-tra Adhesive Slides	Leica - Surgipath	Clipped corners
X-tra Adhesive Slides	Leica - Surgipath	Ground edges 90°
Micro-Slides	Leica - Surgipath	Ground edges 90°
Apex Superior Adhesive Slides	Leica - Surgipath	Ground edges 90°
Superfrost "Plus" white (Menzel glasses)	Leica - Surgipath	Ground edges 90°
Polysine (Menzel glasses)	Leica - Surgipath	Ground edges 90°
VCE Micro-Slides	Leica - Surgipath	Ground edges 90°
Bloodsmear Slides / Art. 3010-SBE Frosted End	Leica - Surgipath	Beveled edges
Bloodsmear Slides / Art. 00375 Doublefrost	Leica - Surgipath	Beveled edges

The following specimen slides were validated for the specimen slide gripper starting with serial number 3000:

**Note**

Leica provides no warranty for the function of specimen slides from other manufacturers or any warranty for their function in the instrument. The instrument operator bears responsibility for any use of specimen slides from other manufacturers.

- Before using specimen slides from other manufacturers, Leica recommends testing them in the instrument.

Name	Manufacturer	Properties and description
Superfrost	Menzel glasses	Ground edges 45°
Superfrost	Menzel glasses	Ground edges 90°
Immuno	Dako	Ground edges 90°
Histobond	Marienfeld	Ground edges 90°
Unimark	R. Langenbrinck	Ground edges 45°/90°
Thin Prep Slides	Hologic Cytoc	Ground edges 90° Clipped corners
Cod.09-OMB95	Bio-Optica	Ground edges 45°
SP Brand Superfrost Micro Slides	Erie Scientific Co.	Ground edges 90°
Adhesive Slides	Knittel	Ground edges 90°
Printer Slides (recommended for Leica IP-S printer)	Knittel	Ground edges 90° Clipped corners
Colorfrost Plus	Thermo Fisher Scientific	Ground edges 90°

12 Appendix A – Application-related notes and recommendations

Name	Manufacturer	Properties and description
Colorfrost Plus	Carl Roth GmbH	Ground edges 45° Clipped corners
Colorfrost Plus	Carl Roth GmbH	Cut edges 90°
Colorfrost Plus	VWR	Cut edges 90°
Colorfrost Plus	VWR	Ground edges 45° Clipped corners

12.5 Cover slips

The use of cover slips specially developed for automated coverslipping is recommended for the Leica CV5030 Robotic Coverslipper. These have been manufactured so as to hinder or prevent multiple cover slips from sticking together.

We recommend:

- Surgipath™ Premier Cover Glass
- Surgipath™ Cover Glass for Automated Coverslippers

When storing cover slips, always make sure the environment is dry. Increased humidity is enough to cause cover slips to stick together, which can impair the coverslipping operation.

12.6 Labels for specimen slides

The Universal Label labels are optimized for use on the Leica CV5030 coverslipper and provide a complete solution for printing and coverslipping in combined usage.

To ensure the best print quality, Leica Universal Label labels have to be used on the Cognitive Label printer. This is available exclusively from Leica Biosystems.

Once printed and affixed to the specimen slides, the Leica Universal Label labels are durable. Fading, aging or detaching do not occur under most extreme conditions, as they are specified by the various staining protocols.

The barcode and text printed on Leica Universal Label labels appears clear and in focus. Even after extreme staining conditions they remain legible and can be scanned without error.

Leica Universal Label:	Label size:	22 mm x 15 mm (7/8" x 19/32")
		1 x 3000 labels, Order No.: 14 0605 46822
		6 x 3000 labels, Order No.: 14 0605 46823

Cognitive Cxi	US Version	Order No.: 14 0605 46820
	EU Version	Order No.: 14 0605 46821

www.LeicaBiosystems.com



Leica Biosystems Nussloch GmbH
Heidelberger Strasse 17 - 19
69226 Nussloch
Germany

Tel.: +49 - (0) 6224 - 143 0
Fax: +49 - (0) 6224 - 143 268
Web: www.LeicaBiosystems.com